



# **TEAM CANADA – PROGRAM OF EXCELLENCE**

---

**HIGH PERFORMANCE PROGRAM**





**PLAYER DEVELOPMENT**  
Développement des joueurs



# **Under 17 Technical Curriculum**



## UNDER 17 TECHNICAL CURRICULUM TABLE OF CONTENTS

INTRODUCTION .....	1
NATIONAL TEAM SELECTION CRITERIA .....	2
Positional Characteristics .....	3
Player Selection .....	4
Team Concept .....	4
TEAM TACTICS AND PRINCIPLES THAT GOVERN PLAY .....	5
INTRODUCTION: DEFENSIVE ZONE PLAY .....	7
Defensive Zone Coverage .....	8
Defensive Zone Coverage Drills .....	9
Key Points .....	11
INTRODUCTION: NEUTRAL ZONE COVERAGE .....	12
Neutral Zone Forecheck 1-2-2 Press .....	13
INTRODUCTION: OFFENSIVE ZONE FORECHECK .....	14
Offensive Zone Forecheck 1-2-2 Press .....	15
Neutral / Offensive Zone Forecheck Drills .....	16
Key Points .....	17
INTRODUCTION: TRANSITION .....	18
Neutral Zone Transition .....	19
Transition Drills .....	20
Key Points .....	22
INTRODUCTION: TRACKING .....	23
Tracking .....	24
Tracking Drills .....	24
Key Points .....	25
INTRODUCTION: BREAKOUTS .....	26
Breakouts .....	27
Breakout Drills .....	28
Key Points .....	32
INTRODUCTION: ENTRIES .....	33
Entries .....	34
Entries Drills .....	35
Key Points .....	38



## **UNDER 17 TECHNICAL CURRICULUM TABLE OF CONTENTS**

INTRODUCTION: OFFENSIVE ZONE PLAY .....	39
Offensive Zone Play .....	40
Offensive Zone Play Drills .....	41
Key Points .....	43
INTRODUCTION: SPECIAL TEAMS .....	42
Power Play Breakouts .....	44
Power Play Offensive Zone Setups .....	46
Penalty Killing Forechecks.....	52
Penalty Killing in Defensive Zone .....	53
INTRODUCTION: GOALTENDING .....	56
Skating Drills.....	57
Butterfly Save and Butterfly Slides .....	62
Scramble Tactics and Powerslides.....	66
Pass Out Tactics and Net Drives.....	70
Traffic Play.....	77
Playing the Puck.....	80
Breakaways and Shootouts .....	83
APPENDIX	
Practice Plans.....	



## INTRODUCTION

This manual provides a foundation for the preparation of Canadian players and coaches through their participation in the Program of Excellence. This technical curriculum is intended as a guide and resource for Branch technical preparation and should not be viewed as an instructional manual that binds each coach. The information contained in this document provides a framework that will enable a coach to implement his own technical package at the Branch level.

This package was developed by former National Team coaches that have experience at each level of the Program of Excellence. Hockey Canada is indebted to these coaches that have taken a concept and built a *foundation for future success*.

In comparing the Program of Excellence to the Canadian High School system, a coach at the U17 Level has an obligation to prepare a U17 for the National U18 Program the same as a Grade 10 teacher prepares a student for grade 11. The grade 11 teacher then prepares students for grade 12 in the same way an U18 coach prepares players for the National Junior team. Each coach and each teacher must follow a curriculum framework that prepares players or students with the best opportunity for success at the next level.

By implementing this technical curriculum at the U17 Branch level, Hockey Canada is building a foundation for athletes to succeed with our National Teams. While it should be the goal of each provincial/regional team to be successful at the Canada Winter Games and World Under 17 Hockey Challenge, the player development process should be at the forefront of program operations and this development component must not be compromised.

This commitment to preparing provincial and regional team athletes is the cornerstone for future World Junior, Senior World and Olympic Champions.







## **NATIONAL TEAM SELECTION CRITERIA**

In order for Branches and regional teams to select athletes that are best suited for the international game and that are the top candidates for future participation in the Program of Excellence it is critical that evaluators follow a certain standard when evaluating players.

Hockey Canada relies on the Head Scout in conjunction with the National Junior Coaching staff to determine the selection criteria to be followed when selecting players on a year to year basis. From season to season the criteria may vary but a number of core criteria remain constant. There are common characteristics that equate to a Team Canada player that is best suited to compete on the world stage.

When selecting players at the regional level there must be consideration given to not only what the player will do for your provincial/regional team but also where this player may fit long term in the Program of Excellence. It is important that players have a fundamental knowledge of the principles put forward in this technical package and are capable of executing these concepts. If we are all on the same page in regards to the type of player that we need to develop through the Program of Excellence the better opportunity we will have to select potential candidates for our National Teams.

The following criteria are presented to assist the Provincial Camp personnel in identifying and selecting quality players to participate in the Program of Excellence.

### **What is a Program of Excellence Player?**

It is important to remember that a POE player will be among the best players in his age group and will be competing against the best players in the world from other countries. Observable qualities include:

- highly skilled, competitive, and intelligent on the ice,
- willing to put personal goals aside and buy into the team concept,
- ready to accept a role different than normally used to,
- able to realize the importance of and play with emotional control, and
- display discipline both on and off the ice.





## Attributes of a Program of Excellence Player:

### **STP: SPEED, TEMPO, PACE**

- ability to think and execute at a high rate of speed on a consistent basis.

### **STRENGTH:**

- competes and play at a high intensity level on a consistent basis.
- competes hard on the puck.
- ability to win 1on1 battles.

## Positional Characteristics

### Goal:

- Agile with good angles and rebound control
- Must be able to handle and move the puck
- Must understand the team concept
- Strong mental skills

### Defense:

- Must be mobile and agile with good lateral movement
- Be able to contain players in 1on1 situations
- Must be a good positional player
- Must be able to read and react in order to move the puck quickly
- Must understand the team concept

### Forwards:

- Must possess excellent skating qualities such as speed, quickness, agility, and strength.
- Must be an intelligent player that understands offensive and defensive systems
- Must understand the team concept.





## Player Selection

The team must have great overall speed and be able to execute quickly. It is important to select skilled players that will commit to a team concept. The goal is to take the most skilled players available and assign specific roles. The “ghost roster” is no longer used to identify specific players to play in specific roles.

The final few decisions on any roster are always a difficult challenge. Many coaches prefer to take “character players” to fill final roster positions. While it is important to have character players, these players must have the necessary skill level to compete and bring a special component to the mix. Examples include special teams play (power play and penalty killing), speed, ability to play different positions etc. Players must also be able to play “up” in the lineup. Experience has shown that taking players with skill who have the ability to fill a role on special teams or replace someone in the top of the lineup are more effective than taking “character” or hard working players who may have less skill. For example, most National Team staffs will take a multi-dimensional offensive defenseman as a 7<sup>th</sup> defenseman because of his ability to play the power play even though he may have some deficiencies in his own end of the ice.

Selecting goaltenders has a unique set of challenges for the coach staff. Rarely will a team win a championship at the international level without great goaltending. The key ingredient for a POE goaltender is a simple one. Each goaltender selected must be capable of being the number one goaltender on the team and must be capable of having standout performances to win games on their own. It is crucial that the backup goaltender be able to fill the role of the number one goaltender.

## Team Concept

Once players are selected it is critical that the team becomes a cohesive unit very quickly. This is where the player’s character and attitude is paramount. Players must realize that the success of the team comes first and that they must contribute in every way they are capable.







## TEAM TACTICS AND PRINCIPLES THAT GOVERN PLAY

Principles are general rules or laws which govern and guide the application of team tactics, systems, and strategies.

Four Principles govern offensive and defensive team play:

Offensive	Defensive
<ul style="list-style-type: none"><li>• Pressure</li></ul>	<ul style="list-style-type: none"><li>• Pressure</li></ul>
<ul style="list-style-type: none"><li>• Puck Control</li></ul>	<ul style="list-style-type: none"><li>• Stall/Contain</li></ul>
<ul style="list-style-type: none"><li>• Support</li></ul>	<ul style="list-style-type: none"><li>• Support</li></ul>
<ul style="list-style-type: none"><li>• Transition</li></ul>	<ul style="list-style-type: none"><li>• Transition</li></ul>

In review of the principles that guide offensive and defensive team play, it should be understood that each of these principles must work inter-dependently of one another. For example, offensive transition can only lead to a quick and effective counteract if there is immediate pressure, good puck control and excellent offensive support away from the puck. If this does not occur, it is possible the opposing team may regain possession of the puck and the attacking team, after giving up possession, is now forced to demonstrate effective defensive transition.

### Pressure - Offensive

Offensive pressure is created through a quick player and/or puck movement that forces the defender to react more quickly or in a different direction than they would like. The goal of pressure is to create increased time and space for the attackers.

### Pressure - Defensive

Defensive pressure is created through a quick player movement that forces the offensive player to react more quickly or in a different direction than they would like. The goal of pressure is to decrease time and space for the attackers.





## **Puck Control - Offensive**

Offensive pressure is created through a quick player and/or puck movement that forces the defender to react more quickly or in a different direction than they would like. The goal of pressure is to create increased time and space for the attackers.

## **Stall / Contain - Defensive**

The principle of defensive play where the defensive team will attempt to force the opponent to stop or slow down the speed of an attack to provide time to set up better defensive coverage. This is accomplished by pressuring the puck carrier or deflecting the attack to the outside lanes/ice.

## **Support - Offensive**

To provide offense, offensive players away from the puck must be available as passing options and be a part of the attack. Players must be able to read the intentions of their defensive counterparts and at the same time read and anticipate the movements and the possibilities of the puck carrier.

## **Support - Defensive**

The player defending against the puck carrier requires the support of teammates to ensure that they are active away from the puck carrier and position themselves in a manner that will eliminate the options of the puck carrier. Players must be able to read the offensive options available to the puck carrier and move to a position that minimizes or takes away these options.

## **Transition - Offensive**

Offensive transition is measured in a teams' ability to move quickly from defense to offense when the puck is recovered. All players must be prepared to move quickly to the attack.

## **Transition - Defensive**

Defensive transition is measured in a teams' ability to move quickly from offense to defense should a turnover occur and the opposing team moves quickly to the attack.





## INTRODUCTION: DEFENSIVE ZONE PLAY

The key to any successful defensive system begins with proper positioning by the players involved. On the international ice surface, there is 15 feet of ice added to the width of the rink, and that good position is critical when defending.

Using the key concept of protecting the middle of the ice, then pressure out from there, players will have a foundation from which to start with. To do this it is important to identify a *home base* (see diagram) which is the most critical ice to protect. Strong net front coverage is essential since teams in international competition have the tendency to work the puck back to the middle before shooting instead of taking the shot from outside. With good positioning, there is no need to chase because international teams will bring the puck to the middle. Patience is an important virtue when defending against the attack.

Protecting the middle is essential, but it is important to continue using the principles of pressure to take away time and space and to force the opposition into making poor decisions. The Canadian game plan will always be aggressive and physical all over the ice, but especially when defending in the defensive zone. However, physical play should never override good defensive positioning.

Play away from the puck is important. As much as players must be prepared to pressure the puck in one on one situations, support away from the one on one is critical. All players must work as a unit and be prepared to defend as a group of five. Communication is a key component in ensuring everyone is clear on their responsibilities and provides support and direction to one another.





## Defensive Zone Coverage

### Drill Name & Description

#### Introduction

- D1 plays X, hit or contain depending on gap.
- F1 plays support for D1.
- F2 plays inside out and up on strong side D.
- F3 helps D2 and plays outside on opposing week side D.
- D2 takes front of the net.

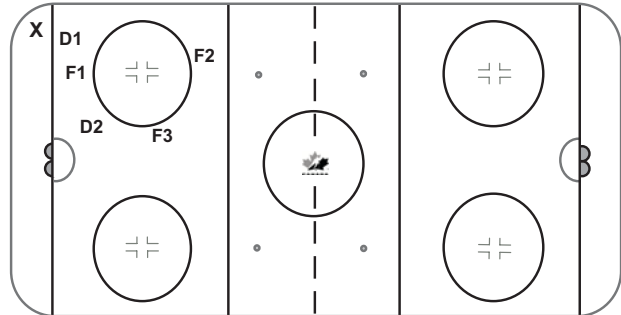

### Drill Name & Description

#### Rotation

- D1 comes back to net.
- D2 checks off for D1. Unless 100% sure he can get the puck, he must stay until D1 reaches net.
- F2 to high slot.
- F3 to strong side point, inside out.
- F1 support other corner from front of the net.

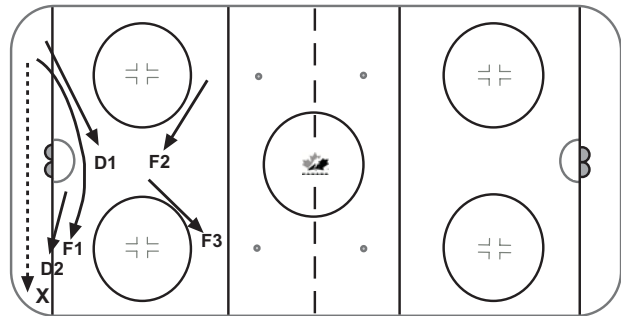

### Drill Name & Description

#### Shade vs Overload

- Net front D shades toward opposing 3<sup>rd</sup> forward taking away his space. He is still able to provide help for D2 or F1 if they get in trouble.
- F2 drops down to protect deeper into slot.

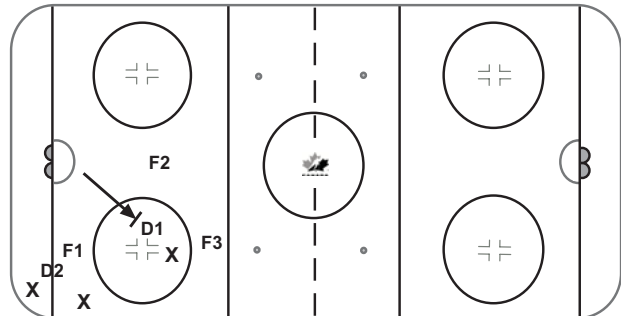



## Defensive Zone Coverage Drills

### Drill Name & Description

#### 1 vs 1 Gap

- 1 vs 1 out of corner where the coach spots a puck to the offensive player.
- Defensive player needs to get the appropriate angle and close his gap to defend the offensive player.

#### Key Teaching Points

- First 3 steps by defender are quick and to get the best position.
- Defender leads with his stick on the puck.
- Stay on defensive side.

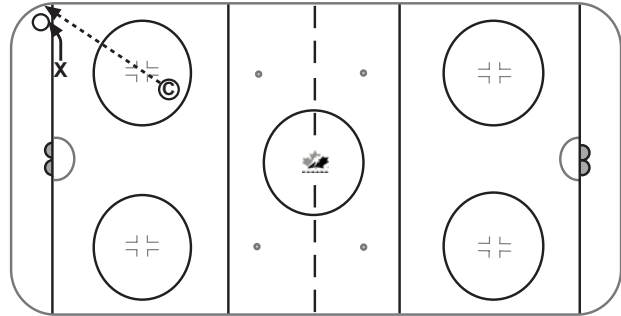

### Drill Name & Description

#### 1 vs 1 No Gap

- Defender works to pin his man since there is no gap.

#### Key Teaching Points

- Stick on puck.
- Stay on defensive side.

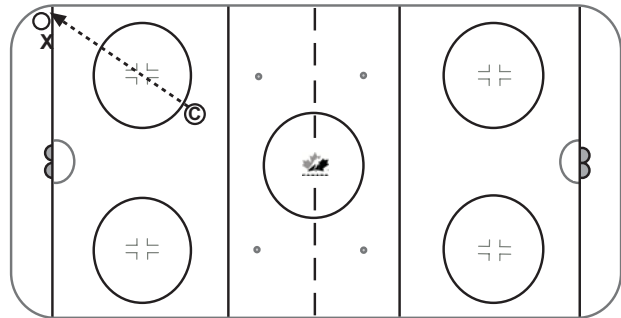

### Drill Name & Description

#### 2 vs 2 Hinge Rotation

- 2 defenders on 2 offensive players.
- Passive drill where 2 defending players move from pressure to support positions on puck movement.

#### Key Teaching Points

- Communicate.
- Stick on puck.
- Support one stick length.
- Straight line skating.

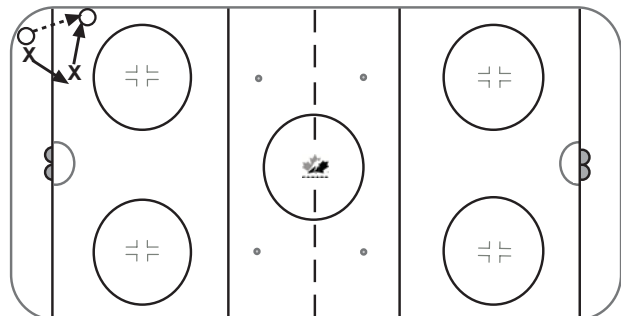





**Drill Name & Description**  
**2 vs 2 Gap / No Gap**

- See 1 vs 1 gap, no gap.

**Key Teaching Points**

- Stick on puck.
- Good angles to close gaps.
- Communicate.
- Straight line skating on rotation.

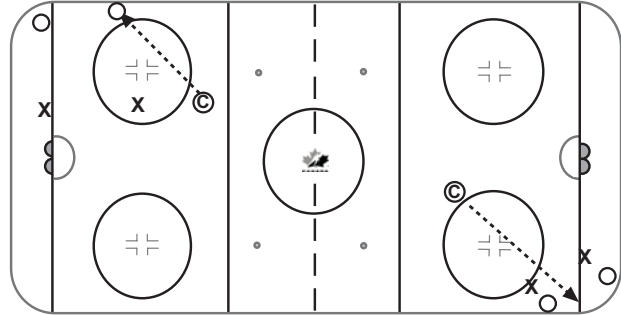

**Drill Name & Description**  
**3 vs 3 Shade**

- 2 vs 2 passive in corner.
- Net front man shades to where the offensive "3<sup>rd</sup> man" goes.

**Key Teaching Points**

- Head on a swivel.
- Communicate.
- Stay between "3<sup>rd</sup> man" and net.
- Shade about half way to your man.

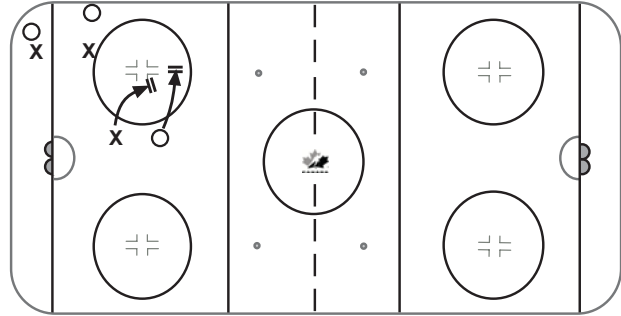

**Drill Name & Description**  
**3 vs 3 Shade**

- Gap, no gap.

**Key Teaching Points**

- Move quick to defend.
- Good angles.
- Communicate responsibilities.

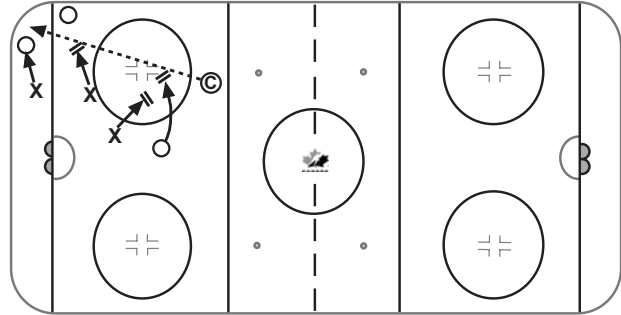



<b>Drill Name &amp; Description</b>
<b>5 vs 5 Rotation</b>
<ul style="list-style-type: none"><li>• Passive coverage to an imaginary offense.</li><li>• Rotate on coaches' command.</li></ul>
<b>Key Teaching Points</b>
<ul style="list-style-type: none"><li>• Back side forward drops between hash marks to protect net front when net front defense shades.</li><li>• Net front defense does not leave until partner takes net front.</li></ul>

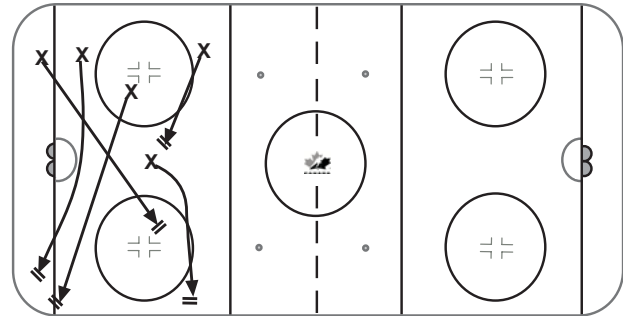

### Key Points

- First man on puck carrier approaches his man quickly with stick on puck and play the body.
- Support man must stay off the pile (about stick length) and communicate to man on puck carrier. His stick should be on the ice.
- Players must skate in straight lines. Reload to middle if you lose position.
- Strong net front coverage.
- Communicate
- Provide outlets on puck recovery.





## INTRODUCTION: NEUTRAL ZONE COVERAGE

Coverage in the neutral zone is critical to successfully defending in the international game since most countries rely heavily on the counter strike mentality. They will want to re-attack quickly and penetrate the middle lane if possible, since they are not as comfortable with the puck to the outside. Therefore it is imperative that we protect the middle of the ice and push the puck to the outside. In the past, some teams have used the mindset of checking from the dots out. This has proven to be a very effective tool since the width of the dots on international ice is identical to that of regulation ice surfaces in Canada. Therefore players are familiar with this, and familiarity often breeds confidence since it is an easy reference point to work from.

For us to forecheck through the neutral zone effectively we must work as a group of five players. The first forward on the forecheck must work very hard to get pressure on the puck so that he forces a poor decision. To get the necessary pressure on the puck, we encourage a three man race to be that first forward, while the two forwards who lose the race fill their roles. In this way we will use the principles of pressure and support when applying our forecheck. This will serve to eliminate any *gaps* in the forecheck that can appear when all five players are not working together. When the forecheck is forced to rotate, players must move quickly to their position in order to defend the next pass.

Stick placement is very useful when forechecking through the neutral zone since a well placed stick will deter a pass through the middle and often times intercept a pass leading to a quick transition to offense.





## Neutral Zone Forecheck 1-2-2 Press

### Drill Name & Description

#### Introduction

- F1 pressures hard up ice inside out and forces pass.
- F2 and F3 come up ice between dots and adjust according to situation. They stay above opposing wingers.
- D1 and D2 close gap but respect the stretch.

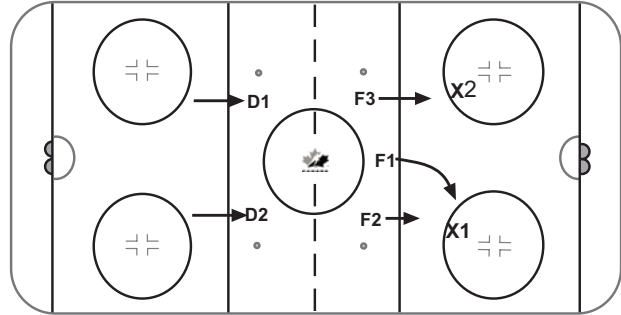

### Drill Name & Description

#### Early Pass

- F1 plays inside out and forces X1 on early pass and takes D to D away.
- F2 & F3 slide with puck movement and take away boards and middle.
- D1 takes away strong side.
- D2 takes away middle and far side.

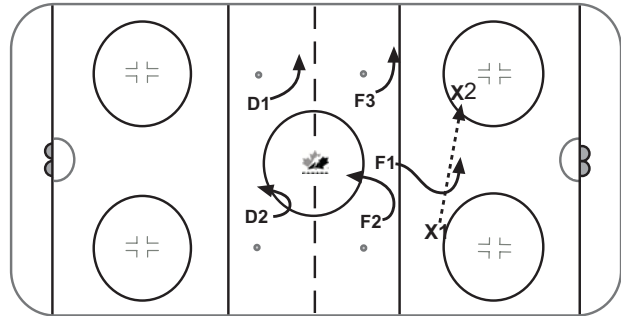

### Drill Name & Description

#### D carries

- F1 pushes puck up the boards.
- F2 takes the boards and plays zone.
- F3 takes middle and plays zone.
- D2 takes boards and keeps people in front of him.
- D1 takes the middle and far side.
- F2 pinches off X1 and F1 supports.

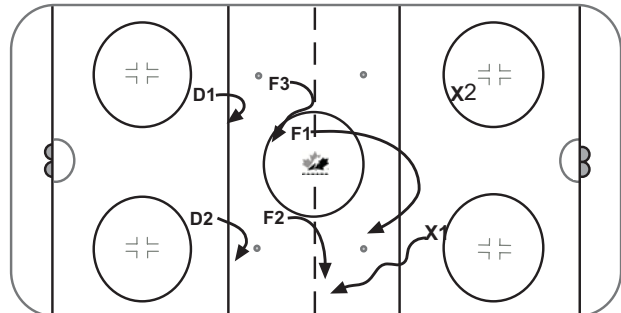



## INTRODUCTION: OFFENSIVE ZONE FORECHECK

An effective offensive zone forecheck is one of the most important tools any Canadian team can have when they are involved in international competition. It is not only a key tactical tool, but it also serves to help develop a trademark for the team. In the past it has been intimidating for European teams to face an aggressive fore check, but in recent years the physical style of play, while still very effective and necessary, has not been as intimidating to them. However, the fact that they are forced to make good decisions plays under extreme pressure is as intimidating as ever since they are not accustomed to that style in their countries.

Most defense in the international game are not used to handling the extreme pressure we like to use in our game. Therefore, pucks will be turned over if we force the opposition to make decision quicker than they are used to doing. For this to be accomplished, we need to embrace an attack mentality that encourages all five players to get up the ice and in position. The first forward sets the tone and we encourage all three forwards to race to be that first man with race ending at about the top of the circles in the offensive zone. Three players are difficult to screen off and it gets everyone moving up the ice quickly. The defense must move up the ice and have a very good gap, however, they are responsible to take the opposing forward if he stretches the zone.

Canada has the reputation for having a very aggressive style of play and that is evident in the way we fore check. The opposition expects us to come hard and we should make a point not to disappoint them.

### HOME BASE:

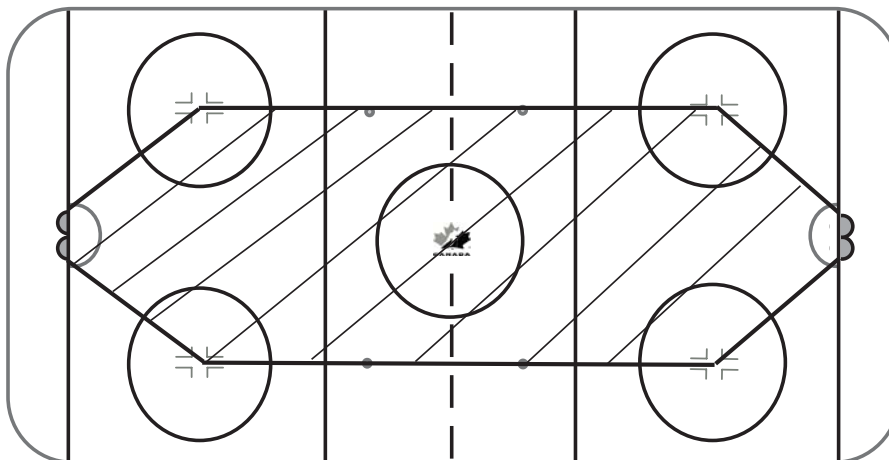





## Offensive Zone Forecheck 1-2-2 Press

### Drill Name & Description

#### Contact

- F1 pressures hard and tries to make contact coming inside out on X1.
- F2 stays above X2 and is ready to jump to corner to help on a turnover.
- F3 stays high and in the middle.
- D1 and D2 get up on the blue line.

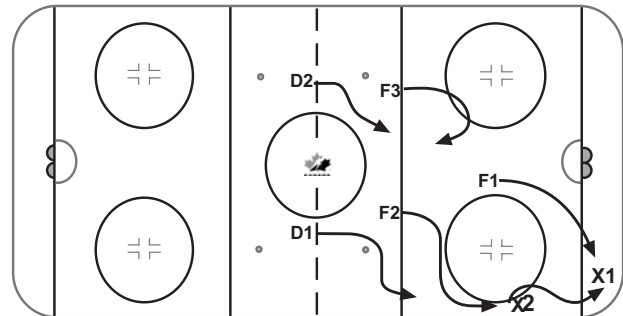

### Drill Name & Description

#### Early Pass

- F1 reads and adjusts his skating pattern and remains the first fore checker.
- F2 takes away the middle.
- F3 adjusts and takes away the boards, staying above the puck.
- D1 adjusts to strong side boards.
- D2 adjusts to take away middle and wide lane.

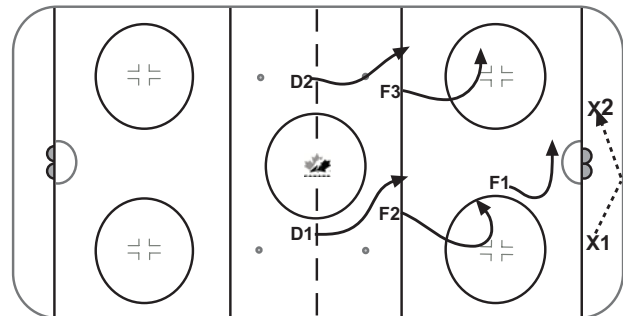

### Drill Name & Description

#### Late Pass

- F1 comes back hard through the middle.
- F3 sees pass and jumps aggressively to X2, looking to finish his check.
- F2 comes across to take away the board side wing.
- D1 and D2 get up on the blue line and slide to adjust to the pass.

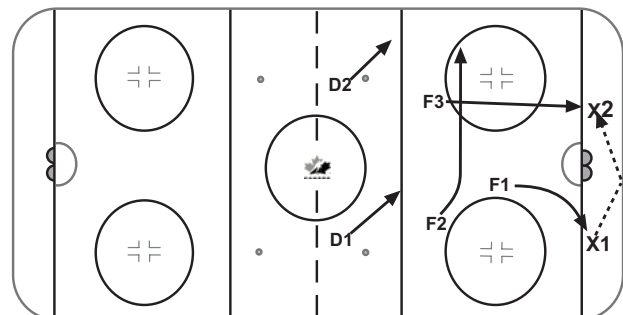



**Drill Name & Description**

**D Carries**

- F1 pursues X and angles him up the boards.
- F2 goes down and gets his gap on X, and gets ready to engage him at or before the blue line, while F1 prevents the inside move and pass to middle.
- F3 fills middle.
- D2 has his gap on the strong side.
- D1 has middle and cross ice pass.

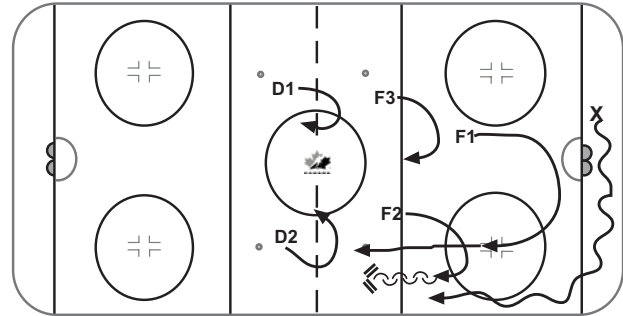

**Drill Name & Description**

**Rim**

- F1 forces hard and comes back through the middle after the rim is made.
- D1 can pinch.
- F3 covers for D1.
- F2 comes hard across above the puck.
- D2 supports and protects middle and wide lane.

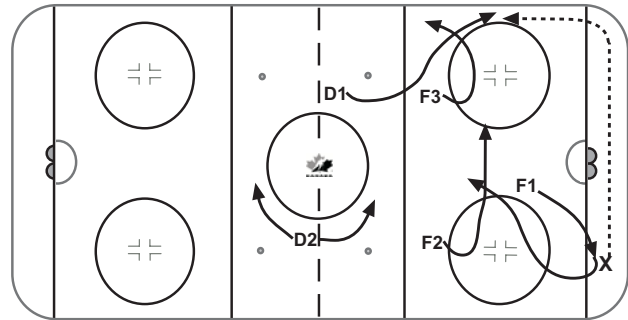

**Neutral / Offensive Zone Forecheck Drills**

**Drill Name & Description**

**Angling Drill**

- Coach at center ice with pucks spots a puck to either line.
- Players react to spot.
- Player on puck side retrieves puck and attempts to come up ice.
- Other player touches up at his blue line and closes the gap to angle outside.

**Key Teaching Points**

- Move up quickly to close gap and establish appropriate angle.
- Good stick placement.

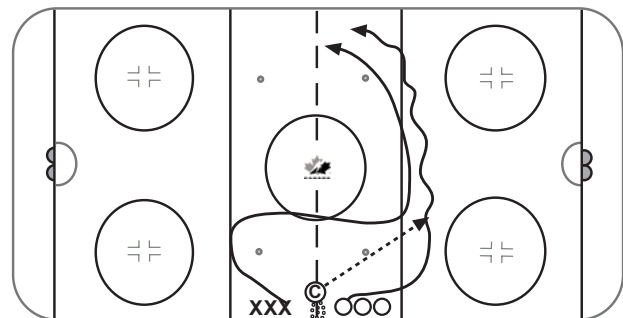



Drill Name & Description
<b>Offensive Zone Forecheck x 2</b>
<ul style="list-style-type: none"><li>• Forechecking forwards (O's) and D mill around the neutral zone and attack the X's on the dump in by the coach.</li><li>• Forecheckers go to position but are passive while forecheckers go to position and cause turnover.</li><li>• 1<sup>st</sup> turnover the puck is returned to the coach while forecheckers come back and regroup at center.</li><li>• 2<sup>nd</sup> time the puck is turned over, forecheckers attempt to score.</li><li>• Rotate to give forecheckers a rest.</li></ul>
<b>Key Teaching Points</b>
<ul style="list-style-type: none"><li>• 3 man race to top of circles to be the first forechecker.</li><li>• Check from dots out.</li><li>• Good stick placement to protect middle of the ice.</li><li>• All five players up to support forecheck and eliminate gaps.</li></ul>

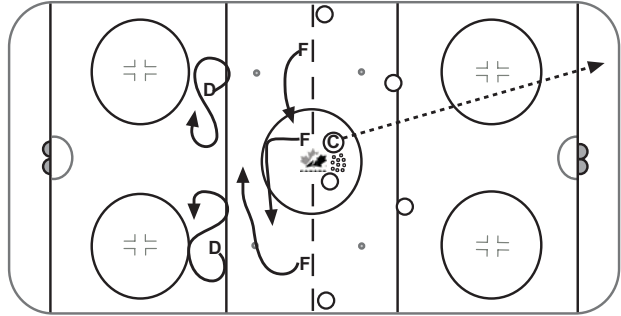

### Key Points

- Defend from the dots out.
- Create a three man race to be the first fore checker.
- First forward cut the ice in half to force the puck up ice.
- Eliminate gaps in the fore check.
- Good stick placement.
- Move quickly on the rotation.
- Recover to the middle.





## INTRODUCTION: TRANSITION

The transition from defense to offense in the neutral zone can help to establish a speed game for your team. Proper support will allow for a very quick transition forcing the opposition to go into transition of their own, from offense to defense. The challenge is which team can force the other to make those decisions under pressure.

Effective transition requires the defenseman to look for a penetrating pass as his first option always. It should be stated that this pass, while very effective, cannot be forced since it is likely to lead to a turn over. However, if the first pass penetrates the defense, it means you have beaten one, two, or three players quickly and the speed at which they have to react is increased significantly. It also allows your team to establish the pace of the attack and not allowing the opposition a chance to fore check and contain to the degree they feel comfortable. This is a very intimidating weapon.

An important key to transition is giving your players the opportunity to build speed through the neutral zone so they can attack the offensive blue line with speed and enter the zone **on the attack**.

The principles of puck control and support lead to effective team transition which allows your team to put pressure on the opposition.





## Neutral Zone Transition

### Drill Name & Description

#### "C" Support

- Has different options available after pass from D1.
- F2 Posting up on wall.
- F1 Supporting the middle of the ice.
- F3 uses width of the ice and stretches to far blueline.
- D1 comes underneath to support partner.

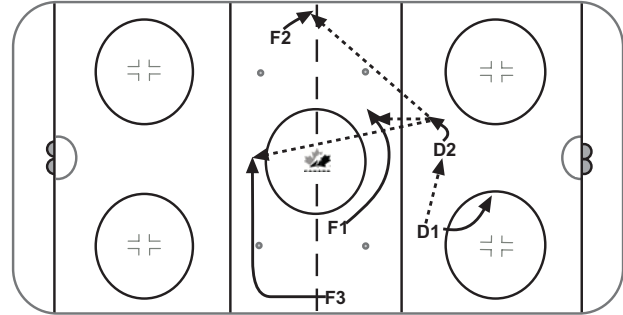

### Drill Name & Description

#### "C" Away

- Same options as above with F1 and F3 exchanging positions.

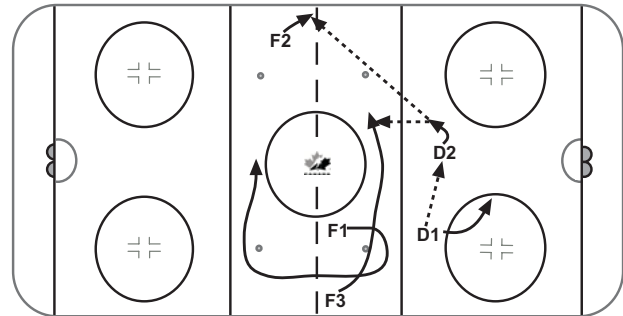

### Drill Name & Description

#### Tap Back

- D1 to D2 back to D1.
- F1 exchanges with F3.
- F3 lends support in middle.
- F2 posts and moves up ice as D2 starts skating and becomes a stretch man.

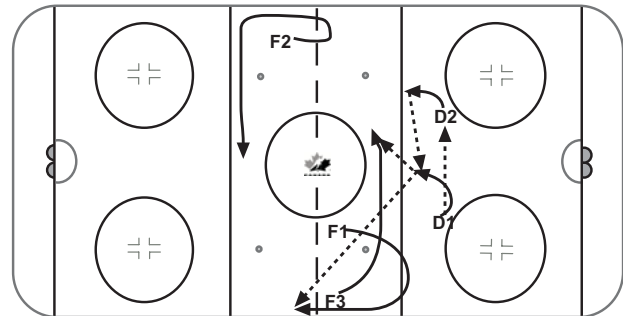





**Drill Name & Description**

**Reverse**

- D1 carries the puck to middle.
- D2 comes underneath and receives a drop pass continuing up ice looking for F2 and F3.
- F1 supports D1 and continues.
- F2 posts then becomes a stretch man.
- F3 pivots to boards and up his wing as an out for D1.

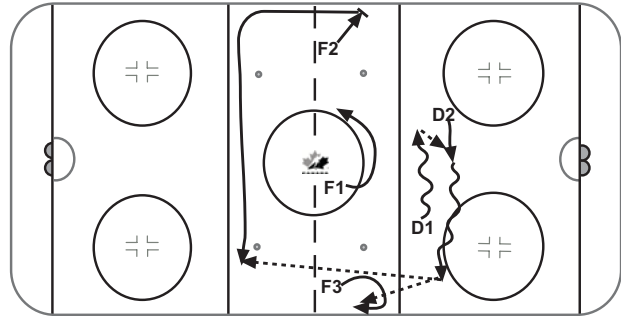

**Transition Drills**

**Drill Name & Description**

**Neutral Zone Up 1 vs 0**

- D1 and D2 on blue line in middle.
- D receives pass from skating toward them.
- X then skates to support for return pass, then skates down for shoot.
- D gets back to middle and looks for pass from other side.

**Key Teaching Points**

- Players sprint to puck in straight line.
- Stop and quickly go back.

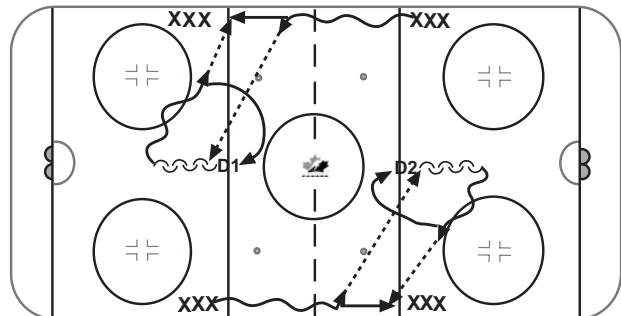

**Drill Name & Description**

**Neutral Zone Up 2 vs 0**

- Same as above except 2 X's skate toward D.
- X1 moves puck to D1 and gets return pass.
- X2 provides middle support to D1 and low support, with speed, to X1.
- X1 can chip puck to X2 or give a direct pass.
- X's go down 2 vs 0 while 2 X's leave from the other blue lines.

**Key Teaching Points**

- D move your feet.
- X2 get over to provide middle support below X1.

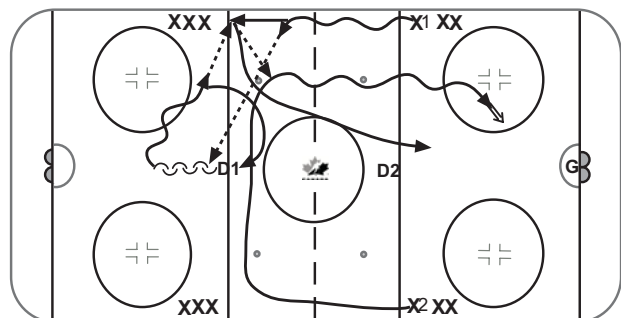



**Drill Name & Description**

**2 vs 1 Transition**

- D1 breaks out 2 forwards who go down on D2.
- D2 receives pass from forwards and quickly moves in transition.
- One forward supports low and the other stretches.
- D2 uses either option.
- Forwards attack D1 2 vs 1.
- D2 retrieves puck in his end and D3 fills in.

**Key Teaching Points**

- D2 quick feet transition and look for penetrating pass option first.

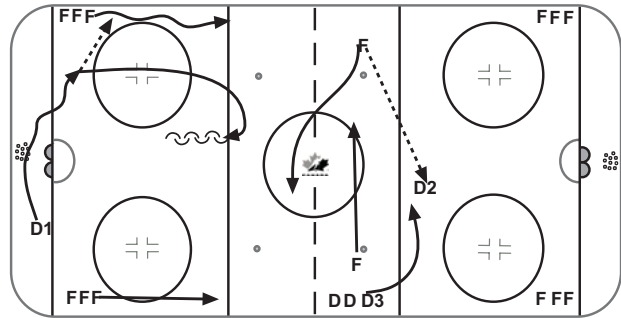

**Drill Name & Description**

**Penetrating Pass**

- On coaches whistle F1 passes to D1 who slides along blue line and shoots on goal.
- F1 goes to net for a screen.

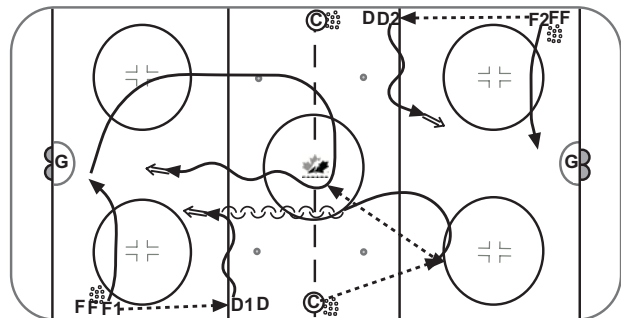

**Drill Name & Description**

**2 Option Transition**

- First D releases and gets pass from next D in line.
- F1 releases and stretches as far as possible staying on side.
- F2 supports low in the middle.
- Depending on Coaches position D passes to F1 or F2.
- First option is F1.

**Key Teaching Points**

- D stay off boards to give yourself an angle for indirect pass.
- F1 stay about stick length off boards to protect puck.
- F2 save ice for support through middle.
- F2 go with speed on stretch pass.

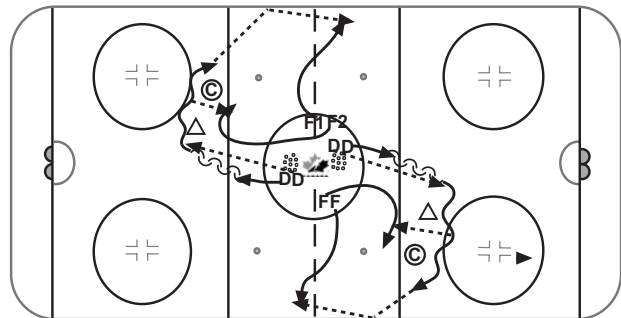



**Drill Name & Description**  
**D Exchange Options**

- Drill begins out of opposite corners.
- X carries puck to 1<sup>st</sup> blue line and moves it to D1 who back peddles and carries puck across as if to draw an opposing player.
- D2 supports below and moves toward middle receiving pass from D1.
- D2 steps up and passes to X who has skated across ice, X then goes down for a shot.
- D2 support from below puck.

**Key Teaching Points**

- Protect puck and draw coverage.
- D2 communicate, receive pass, step up.

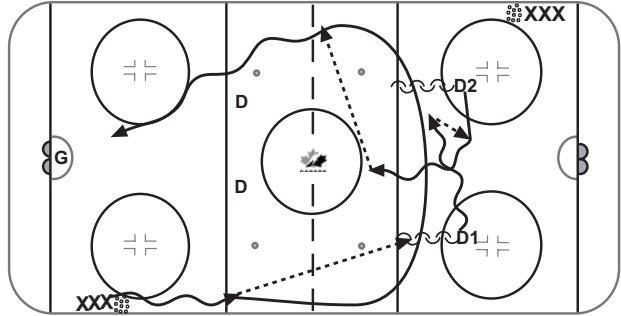

**Drill Name & Description**  
**Regroup Relay**

- On whistle Coach spots a puck for 5 X's to regroup.
- As soon as they advance puck for attack Coach blows whistle for O's to regroup.

**Key Teaching Points**

- All X's must get up on the rush to clear way for O's to regroup.
- Look for penetrating pass as 1<sup>st</sup> option.

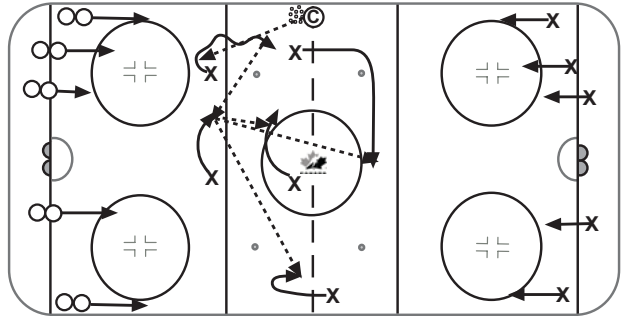

**Key Points**

- Defense must get back to pucks quickly and forwards to outlet position.
- Defense, check their shoulder when retrieving pucks to read pressure and outlets.
- Defense partner always provide support from the back side (stagger).
- Look for a penetrating pass as the first option.
- Use the full width of the ice.
- Stretch the defense.
- Support the puck on three sides.
- Quick puck movement is the first step in a speed game.





## INTRODUCTION: TRACKING

Tracking is simply another word for back checking. An effective track can take a lot of pressure off the defense and put a lot of pressure on the attacking forwards. It requires us to apply the principles of pressure, support and transition to accomplish an effective track.

This tactic can be very intimidating to play against since it sends a message to the opposition that we are *all committed* to working in order to retrieve the puck. It builds confidence with the defense because they know they are getting support from three forwards. It applies pressure on the opposition from the front and back sides, forcing them to make a play with less time and space than they are comfortable with.

This tactic is a very effective way to protect the middle of the ice with the support from the tracking forwards coming through the middle of the ice.

The tracking forwards will find that the better they execute the track, the more effective their transition from defense to offense will be. This is because they are more readily available for a quick pass in transition and, since they have worked hard skating back, they have created separation between themselves and the opposing defense. This will make them more difficult to defend.





## Tracking

### Drill Name & Description

#### Introduction

- When forwards are on the offensive side of the puck, they track puck carrier from the back side.
- They will stay inside the dots when coming back to help take away middle.
- They pressure through until the red line when they communicate responsibilities. Back side awareness is critical.

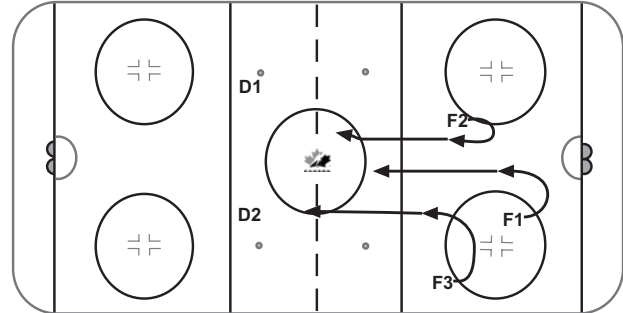

## Tracking Drills

### Drill Name & Description

#### Transition Track

- X1 and X3 leave at same time, drive wide and shoot.
- They recover with 5 hard strides to track thru middle and put backside pressure on X2 and X4 respectively.

#### Key Teaching Points

- Recover on transition with 5 hard driving strides.
- Track back between dots.
- Stick on ice.

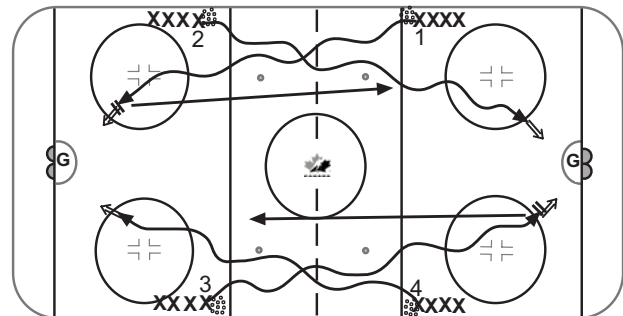

### Drill Name & Description

#### 1 on 2 Track

- Drill begins with F1 on dot and D1 comes down outside in to get his gap while F2 sprints across to take the loose puck

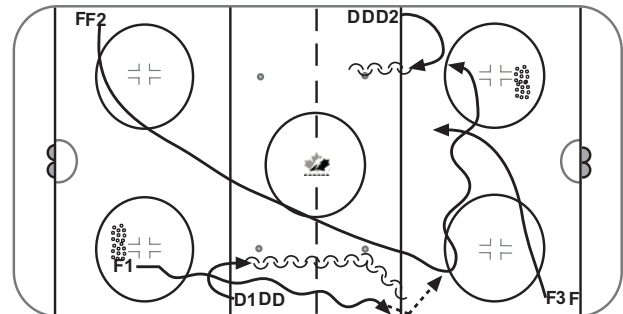



<b>Drill Name &amp; Description</b>
<b>Cycle to Track Transition</b>
<ul style="list-style-type: none"><li>• Forwards are cycling vs O1 and O2.</li><li>• On whistle coach feeds a puck to O's who are joined by O1 and O2.</li><li>• Forwards track back thru middle and must outnumber O's and their own blue line.</li><li>• Drill is played until the whistle blows.</li></ul>
<b>Key Teaching Points</b>
<ul style="list-style-type: none"><li>• Defense play tight gap and stall attack in necessary.</li><li>• Forwards track between dots.</li><li>• Defense communicate thru neutral zone.</li><li>• Forwards need backside awareness at their blue line.</li></ul>

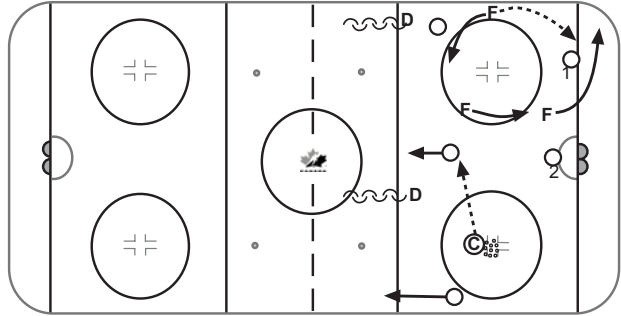

### Key Points

- Four or five driving strides in transition from offense to defense.
- Track back between the dots.
- Stick on the ice to take away passing lanes.
- Out number at the defensive blue line.
- Feed the offensive forward into the defender.
- Forward slide in behind for support.
- Backside awareness and defensive blueline.







## INTRODUCTION: BREAKOUTS

In most breakout situations players are required to read and react to situations quickly. Ideally, the breakout would provide a quick transition to the attack, maintaining puck control and penetrating the opposition's defense putting pressure on them. For a breakout to be effective, the players must have multiple options available to them. To ensure this happens players must use the width and depth of the ice to their advantage so as to *spread* the defense and provide support on three sides of the puck.

Communication is needed to allow for a quick reaction time for the player playing the puck. While he will read the fore check as he retreats for the puck, a teammate who communicates with him will not only save him valuable seconds, but will also increase the chances of a productive play being made. This will lead to a quicker more productive breakout and therefore a more intimidating attack. Key words for fast breakouts have proven to be useful and therefore we suggest the terms *up*, *over*, *wheel*, *reverse* and *wrap* as the terms introduced to the players.

The international game often requires us to use a controlled breakout option. This option, while not a favorite in the Canadian game, is useful to break trap type situations. Although the controlled breakout option calls for pre-determined skating patterns, the same principles of support, puck control and pressure apply.

A team that effectively moves the puck out of its own end and re-establishes an attack, frustrates the opposition by breaking their fore check, and intimidates the opposition with its speed of attack.





## Breakouts

### Drill Name & Description

#### Wheel

- D1 retrieves puck and wheels the net.
- D2 screens and holds the net.
- F2 anchors on the wall.
- F1 supports through middle and is an option.
- F3 is an option to support or to stretch.

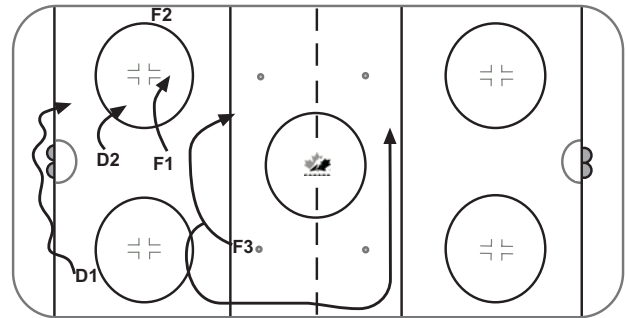

### Drill Name & Description

#### Up

- D1 retrieves puck and turns it up near side.
- D2 screens and protects net front.
- F1 supports low and is an option.
- F2 opens up and is an option on the wall.
- F3 supports coming across or by stretching.

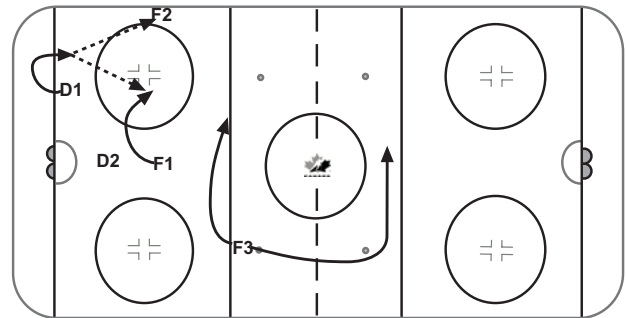

### Drill Name & Description

#### Over

- D1 retrieves puck and passes to D2.
- D2 releases from net front and is an option for D1.
- F3 opens up and anchors on wall.
- F1 supports D and is an option in the middle.
- F2 is an option to support across or stretch.

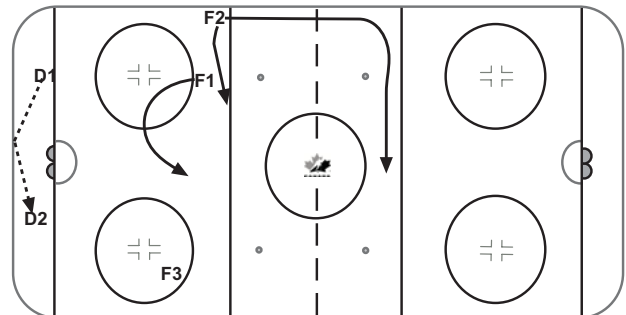



**Drill Name & Description**

**Reverse**

- D1 retrieves puck & begins to wheel net.
- D2 holds net front and calls REVERSE, then leaves to get the puck.
- D1 reverses puck to D2 using boards, then returns to front of net.
- F3 anchors and F1 and F2 can support or exchange lanes.

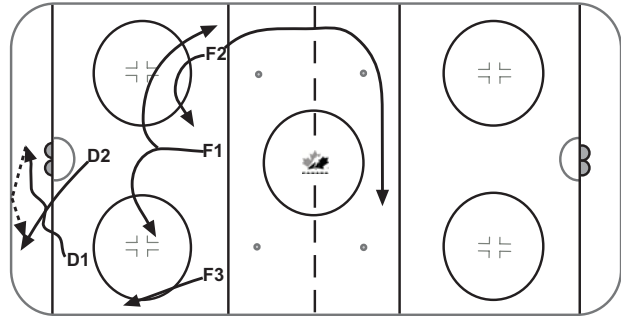

**Drill Name & Description**

**Wrap**

- D1 retrieves puck and reads pressure.
- D2 holds net front and protects middle.
- F2 reads wrap and cuts off support to go to blue line for puck.
- F1 supports below the puck.
- F3 comes hard across and stretches.

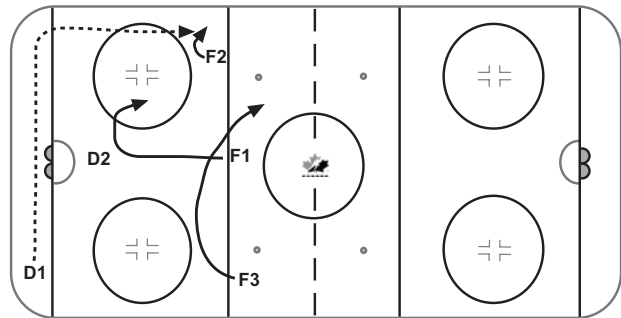

**Breakout Drills**

**Drill Name & Description**

**Split Groups – Forward and Defense**

- “UP” option x 2 D1 skates up and cuts blue line, back peddles to top of circles, pivots and retrieves the puck.
- He turns puck up and passes to first Defense in line who spots it in the corner again.
- D1 repeats the “UP” and skates to blue line, receives a pass, drags it across blue line for a shot.

**Key Teaching Points**

- Back quickly to pucks.
- Check your shoulder for pressure and outlet.
- Approach puck on an angle.

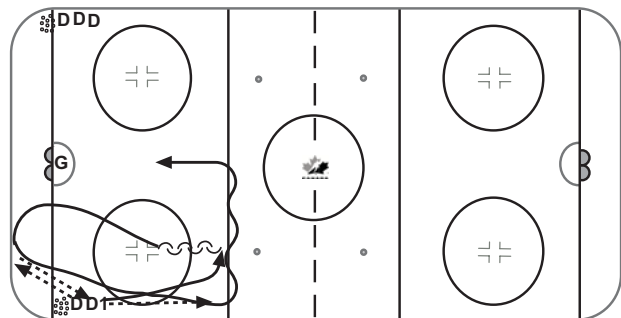



**Drill Name & Description**

**“Wheel” Option x 2**

- D begins same as above.
- Retrieves puck and wheels net to outlet to D on hash who spots puck to the corner.
- D touches up at blueline and completes same sequence on the other side finishing with same shot as above.

**Key Teaching Points**

- Back to puck quickly.
- Check shoulder for pressure and outlet.
- Move puck quickly.

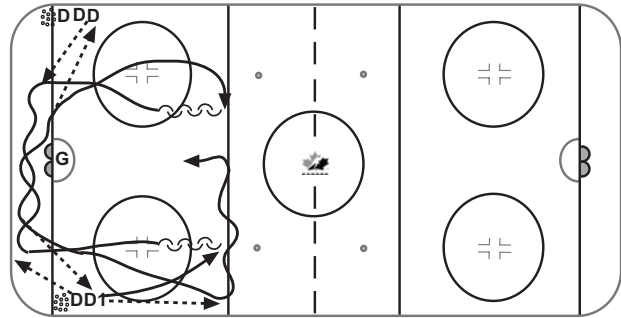

**Drill Name & Description**

**“Over” Option x 2**

- Same sequence as above except 2 D touch up, over puck, touch up, over the other way, skate up to blue aligned with dots, receive pass and shoot puck or pass to partner for shot.

**Key Teaching Points**

- Back quickly, check shoulder.
- Communicate outlet.
- “OVER” the puck so it is off the boards and less difficult to play.

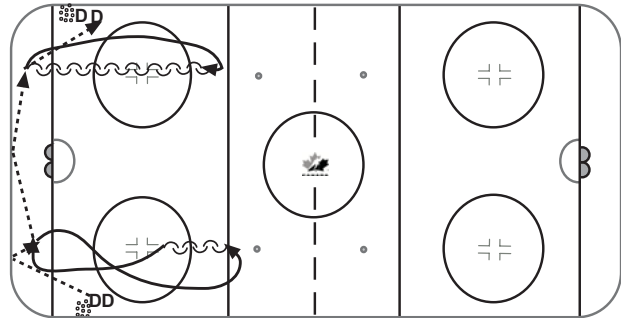

**Drill Name & Description**

**“Reverse” Option x 2**

- Same sequence as above.

**Key Teaching Points**

- Back quickly.
- Protect the front of the net, communicate outlet, puck is reversed off the boards and behind pressure.
- Skate into puck.

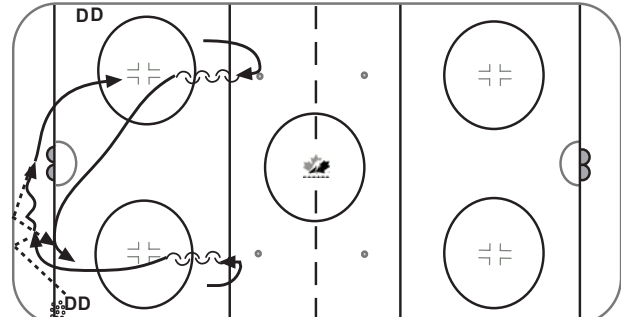



**Drill Name & Description**  
**Breakout Progression**

- “UP” D, quick feet to top of circle down through dot
- Retrieve puck an up to forward who drops to hash mark.
- Forward goes down for shot and D join.
- Can exchange puck while going down ice.
- Go on whistle.

**Key Teaching Points**

- Quick feet, check shoulder, communicate, move puck quickly.
- D joins for support and to close gap.

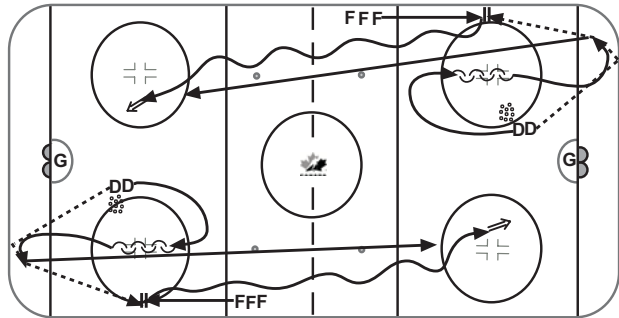

**Drill Name & Description**  
**“Wheel” Breakout Progression**

- Same as above.

**Key Teaching Points**

- Move puck at second post.

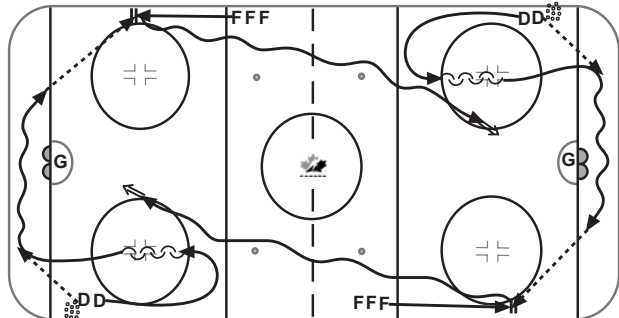

**Drill Name & Description**  
**“Over” Option**

- Same drill as above except now 2 D involved for the over.
- D2 joins rush, then goes to hash mark on the wall.
- D1 fills in for D2.
- Drill goes on Coach’s command.

**Key Teaching Points**

- Quick feet, check shoulder, D2 feet pointed up ice to identify outlet, communicate, move puck, move feet.

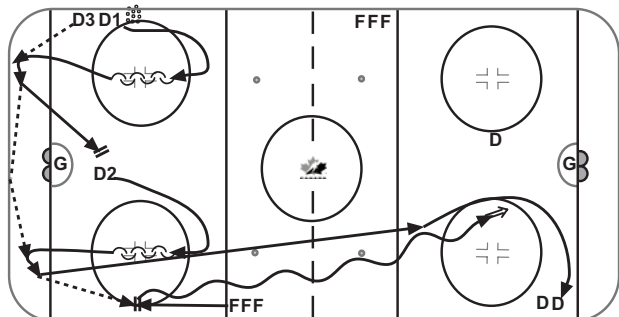





**Drill Name & Description**  
**Reverse Option**

- D1 spots puck for himself.
- D1 reverses to D2 who moves puck to forward.
- D2 joins play and fills in on middle hash mark.
- D1 reverses puck then joins line on hash marks on the wall.

**Key Teaching Points**

- Quick feet, protect net front, communicate.

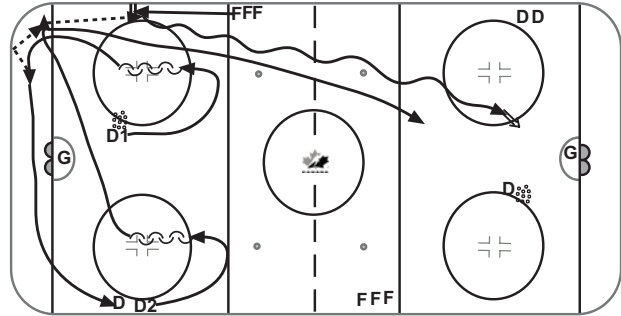

**Drill Name & Description**  
**Breakout Progression 2 Forwards**

- Each drill above can include a second forward providing middle support.
- Puck can be moved to wall then to middle using direct or indirect pass.

**Key Teaching Points**

- Middle support must time his skate, come from underneath for support, communicate to other forward for direct or indirect pass.

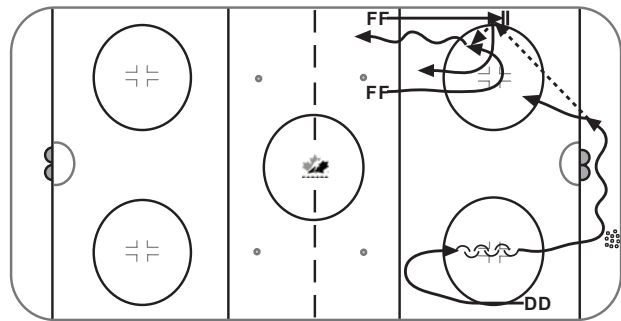

**Drill Name & Description**  
**Continuous Breakout vs Pressure**

- X's Breakout and X forwards enter zone for scoring chance.
- X D's sprint to bench.
- As X forwards enter offensive zone 5 O's come onto the ice.
- Coach shoots puck into zone and O's go back to breakout.
- One, two or all three X's will pressure breakout.
- Coach times the shoot in to get desired pressure.

**Key Teaching Points**

- Back quickly, provide screens, check shoulder, provide outlets, communicate, good changes.

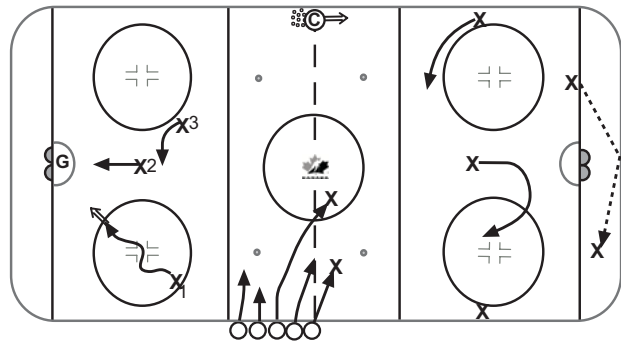





## Key Points

### Controlled Breakout

- Players must provide support from three sides.
- D2 must be lateral or below his partner.
- Stick must be available for the pass.

### Up, Over, Wheel, Reverse, Wrap

- Defense must get back to the puck quickly, checking his shoulder for pressure and outlets.
- Defense partner must screen for his partner or provide an outlet, but he must always communicate best available option before his partner gets to the puck.
- Forwards must sprint back to position to provide an outlet.
- Forwards must read the situation, anticipate the first pass, and react to provide support for second pass option.
- The quicker the first pass is made, the faster the team breaking out brings its attack to high speed. The two most important factors in this case are communication and puck movement.





## INTRODUCTION: ENTRIES

Entries in the international game are critical and special emphasis must be paid to this area. Teams in international competition rely on transition and a quick strike mentality to a large degree, especially since the two line pass is not in play. Turning a puck over at the offensive blue line is a critical mistake in the Canadian game because we have an attack mentality and as such, the other four players on the ice are thinking attack while the puck is being pushed up the ice the other way. We believe giving players the tools to effectively enter the offensive zone using the principles of support, puck control and pressure allows them to play with a strong Canadian attack mentality.

Including a net drive mentality accomplishes a number of things. It provides an attack mentality that is a big part of the Canadian game. It stretches the zone and forces the defense to make a decision on whether to take the player to the net or protect the slot. It forces the defending team to read and react at a higher speed. It also is intimidating to a goaltender who is facing a shot from the outside while he sees a player attacking the net at high speed. The goaltender's attention may be divided, but certainly he has to be concerned about the second shot possibility or the pass that may be made. This will force him to play a little deeper in his net. Typically, goaltenders who play the international game do not face a lot of traffic, and therefore are forced to work harder than normal under more crowded conditions. This can be very frustrating for a goaltender that is not used to these conditions.

Maybe the most important aspect about a good mid lane drive is that it helps to establish an attack mentality that can lend to the development of a team's personality.





## Entries

### Drill Name & Description

#### Mid Lane Drive

- F1 attacks the offensive blue line and takes puck to the net.
- F3 drives the mid lane aggressively.
- F2 reads play and can drive the net or go to slot for high pass.
- D1 and D2 move up on the play and are available to fill in the high slot if open.
- Fill the open ice.

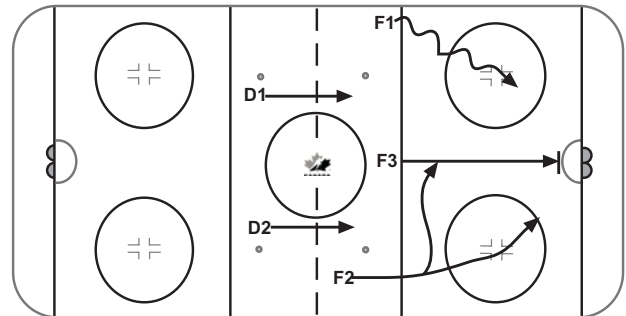

### Drill Name & Description

#### Wide Delay

- F3 drives wide with puck and reads he is not able to get to the net. He cuts back and protects puck making all options available.
- F2 drives net through the mid lane aggressively.
- F1 drives net drawing defenders deep.
- D1 and D2 activate and are available as high options.
- F3 becomes the high man after the pass.

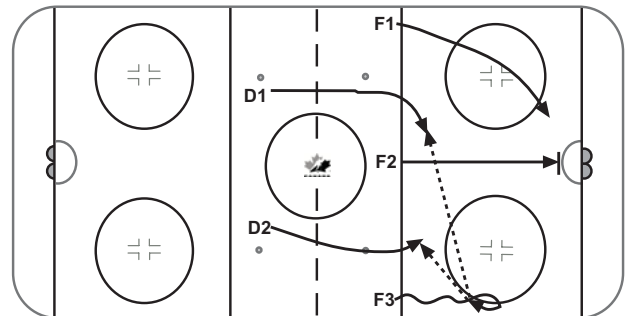

### Drill Name & Description

#### Cross

- F2 looks for the open ice – either in front (soft gap) of or behind the opposing D.
- F3 reads soft gap and crosses behind F2.
- F2 either gives puck to F3 or keeps it. Both players continue to attack net.
- F1 drives the net hard drawing defenders deep.
- D1 and D2 activate and are available in high slot.

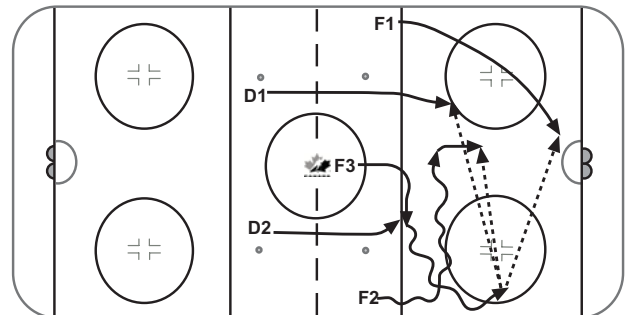



Drill Name & Description
<b>Chips</b>
<ul style="list-style-type: none"> <li>F1 has the puck and is challenged by opposing D.</li> <li>F3 reads and provides close support to pick up chip (F3's speed should not be sacrificed).</li> <li>F2 drives the net trying to get inside position.</li> <li>D activate and are available to find open ice.</li> </ul>

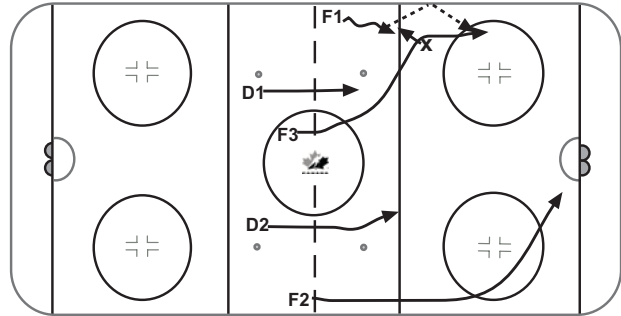

**Entries Drills**

Drill Name & Description
<b>Split Groups – Forwards and Defense</b>
<ul style="list-style-type: none"> <li>Net Drive.</li> </ul>
<b>Key Teaching Points</b>
<ul style="list-style-type: none"> <li>Hard driving strides to net from blue line.</li> <li>Stop at net.</li> </ul>

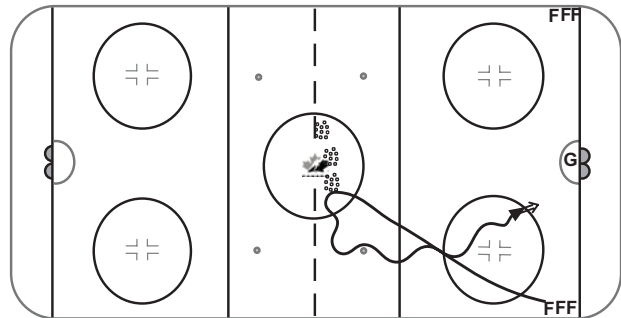

Drill Name & Description
<b>Chip and Chase</b>
<ul style="list-style-type: none"> <li>Freeze the coach then chip out side and chase inside.</li> </ul>

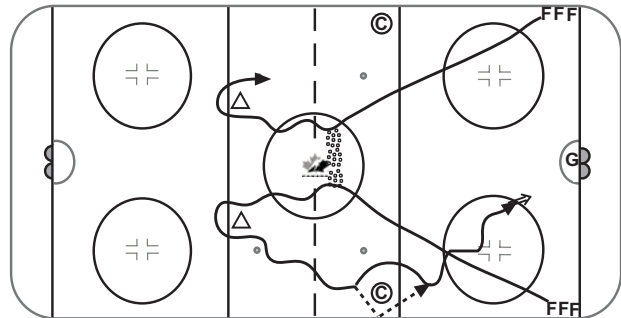



**Drill Name & Description**  
**Wide Delay**

- Attack Coach with speed to back him off.
- Tight turn protecting puck and drive the seam.

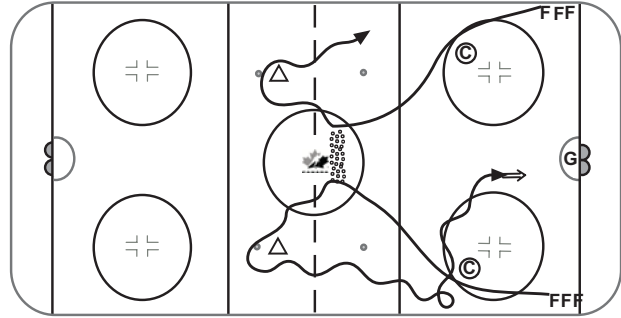

**Drill Name & Description**  
**Cross**

- Attack with speed and identify open ice in front of coach.
- Tight cross to maintain speed.
- Protect puck.
- Drive seam.

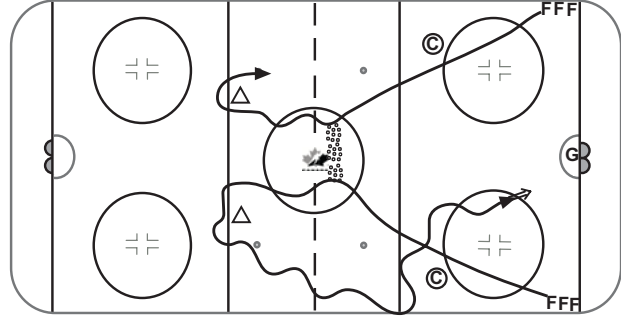

**Drill Name & Description**  
**Net Drive**

- X1 and X2 leave on whistle.
- X1 takes puck around the cone and up the boards while X2 cuts hash marks and sprints over to support.
- X2 receives pass and drives wide while X1 goes to the middle driving mid lane directly to far post.

**Key Teaching Points**

- Keep feet driving through hash marks.
- Drive to par post.
- X2 go to the net after the pass.

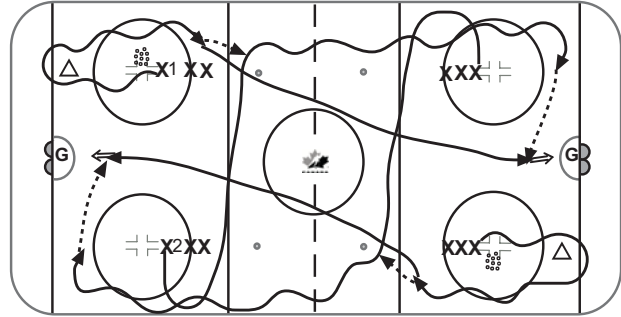



**Drill Name & Description**

**2 Man Support and Chip**

- X1 and X2 leave on whistle.
- X1 takes puck and feeds X2 going up the boards then skates to support.
- X2 draws coach to him and chips puck to open space for X1 to skate into it.
- X2 rejoins X1 on the rush.
- Both ends same time.

**Key Teaching Points**

- X1 works to support.
- X2 waits for coach to commit then moves puck to open space.

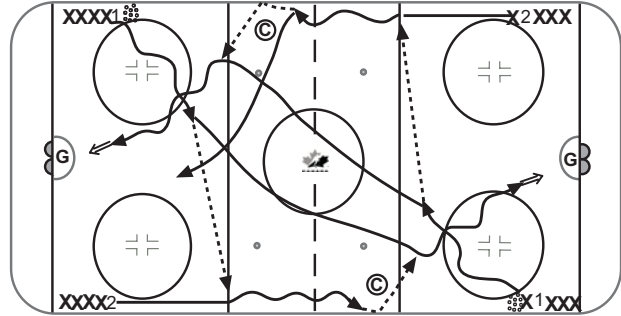

**Drill Name & Description**

**2 Man Wide Delay**

- Same drill as above except coach pressures deeper.
- X1 saves his ice in neutral zone to ensure he is an option.
- X2 looks for X1, then fills in as a high man.

**Key Teaching Points**

- X2 drives deep and off the boards to create space.
- Protect puck on the delay.
- X1 save ice for timing purposes.
- X2 fill in as high man.

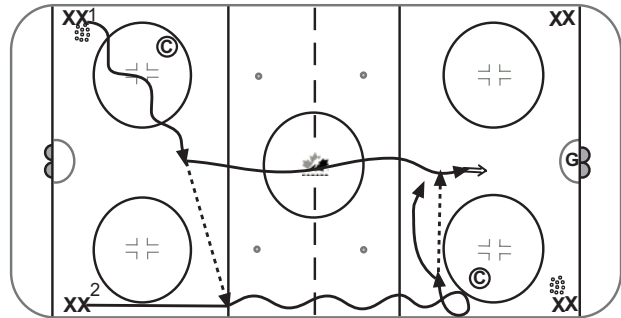

**Drill Name & Description**

**2 Man Cross**

- Same as above, except X1 and X2 execute an offensive cross at the blue line.
- Can be a drop pass for X1 with drive or X2 can keep and drive or keep and feed to X1.

**Key Teaching Points**

- Play without puck support from behind on cross.
- There must be a net drive after the cross.

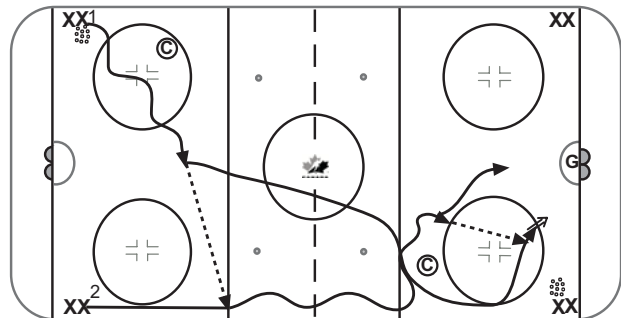





**Drill Name & Description**  
**3 Man Drive**

- X1 comes across zone with puck and drops for X2 coming off other side.
- X3 delays and joins the rush.
- 3 players exchange puck through neutral zone and prepare to enter zone vs two passive D.
- Coach can dictate desired zone entry.

**Key Teaching Points**

- Puck support.
- Net drive.
- Speed on the rush.
- Form attack triangle.

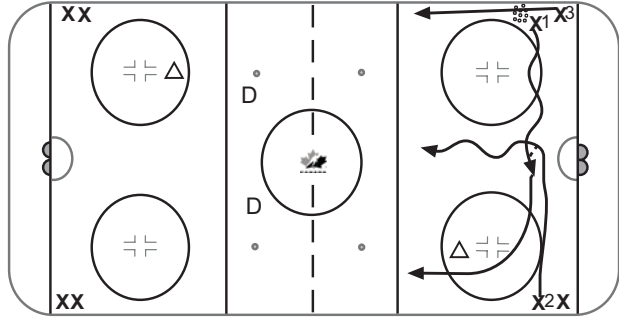

**Drill Name & Description**  
**Breakout 5 vs 2**

- X's perform breakout and attack against 2 D defending with full pressure.
- X's need to read and react to choose proper entry.
- On whistle X's regroup and D get gap to defend 2<sup>nd</sup> rush.

**Key Teaching Points**

- Attack with speed thru neutral zone.
- Proper puck support necessary.
- Communicate.

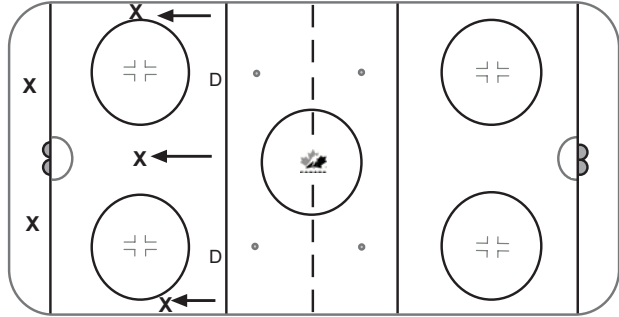

**Key Points**

- The puck **must** be advanced at the offensive blue line.
- Speed must be maintained.
- There must be an aggressive mid lane drive.
- Five players must be up on the play.
- There should always be a high slot presence.





## **INTRODUCTION: OFFENSIVE ZONE PLAY**

Effective offensive zone play is very much a trade mark of Canadian hockey. By enjoying a territorial advantage during the course of a game the opposition is forced to react to what you are doing. Defending is much more taxing both physically and mentally than attacking and therefore there is an attrition effect as a game goes along.

There are various forms of effective offensive zone play, but it should be understood that while territorial advantage is important, developing scoring chances is the main aim. It should also be understood that good decisions and positioning are also important and so patience is a quality not to be under-estimated.

Effective offensive zone play requires that the principles of pressure, puck control and support employed by all five players on the ice. It is essential that players communicate to each other and work to move puck away from defensive pressure so as to take advantage of seams that may open up as a result of broken defensive coverage.

Forwards should funnel to the net on all shots with a second shot mentality.

Offensive zone play requires hard work and players willing to jump to opens spaces and moving quickly to areas after they move the puck. There must be a commitment to get pucks through to the net in order to take advantage of this sprint to the net.





## Offensive Zone Play

### Drill Name & Description

#### High Cycle

- F1 cycles up and looks to drive high seam to the net. If not, all players available for pass.
- F2 fills in the open ice low and is available if F1 has no direct pass option.
- F3 goes to the net.
- D1 is a safety.
- D2 can activate down back side.

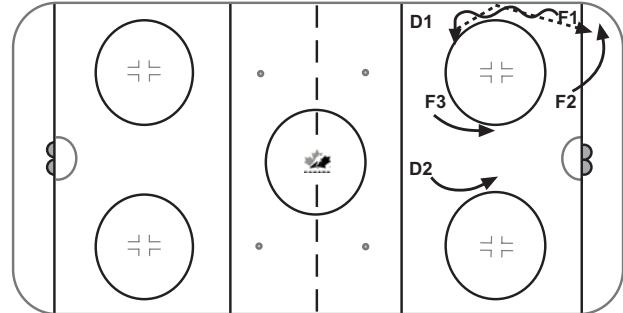

### Drill Name & Description

#### Low Cycle

- F1 drives low and looks to go to the net. If there is no drive lane, the cycle begins.
- F2 holds net front, but slides up between hash marks.
- F3 slides to the wall to fill in the open ice left by F1.
- D1 is the safety.
- D2 can activate and read open space.

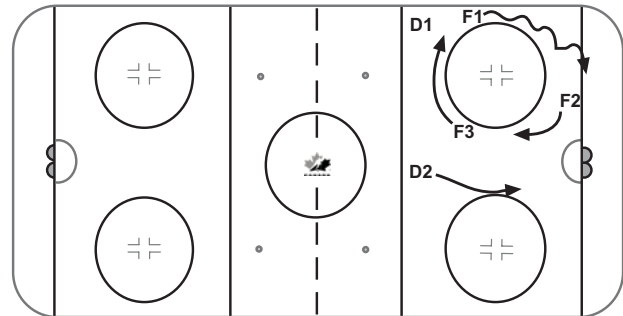

### Drill Name & Description

#### D Cycle

- This comes from the same formation as the high cycle.
- F1 comes up the wall to the blue line.
- D1 slides down the wall on the board side.
- There is a puck exchange between F1 and D1.
- D1 looks to go to net, or take the option to pass to F2 or F3.

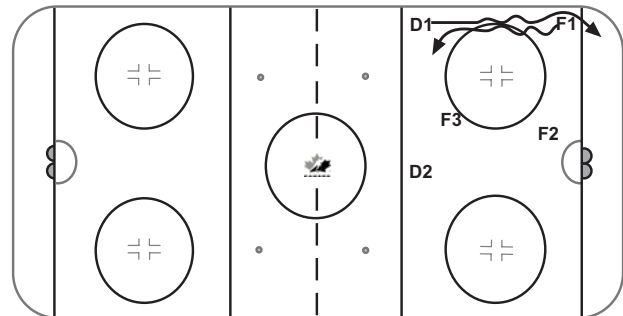



Drill Name & Description
<b>Back of Net</b>
<ul style="list-style-type: none"> <li>F1 in the corner slides puck to F2 who jumps behind net using near post to screen off opposing player.</li> <li>F1 jumps to near post and establish position.</li> <li>F3 goes to far post and establish position.</li> <li>D1 can activate to near dot if he reads play.</li> <li>D2 can activate to far dot if he reads play.</li> </ul>

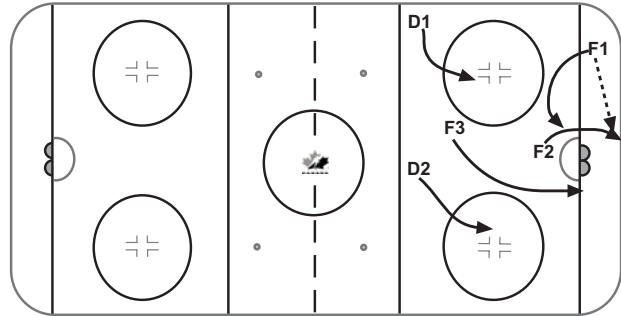

**Offensive Zone Play Drills**

Drill Name & Description
<b>Change Point of Attack</b>
<ul style="list-style-type: none"> <li>X1 jumps to loose puck while X2 holds net front and supports to open ice.</li> <li>X2 receives pass and drives net.</li> </ul>
<b>Key Teaching Points</b>
<ul style="list-style-type: none"> <li>X2 holds net front to draw coverage.</li> <li>Communicate and release quickly to loose puck.</li> <li>Drive net.</li> </ul>

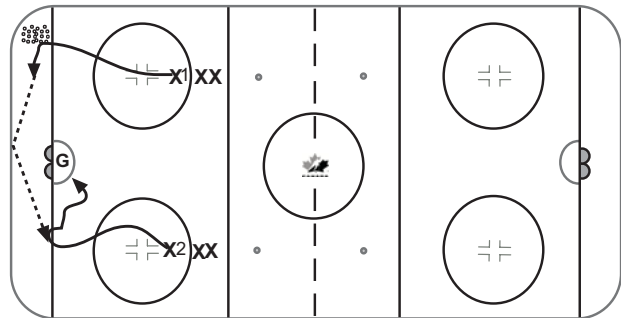

Drill Name & Description
<b>D Cycle</b>
<ul style="list-style-type: none"> <li>X1 goes in for shot and releases to corner.</li> <li>He carries puck up wall past top of circles and X2 drives down wall.</li> <li>X1 reverses puck down wall to X2 who drives the net for a shot.</li> <li>X2 then releases to corner to take puck up wall for X3.</li> </ul>
<b>Key Teaching Points</b>
<ul style="list-style-type: none"> <li>X1 drives up wall to draw coverage.</li> <li>X1 protect puck and create lane for X2.</li> <li>X2 communicate and drive seam.</li> </ul>

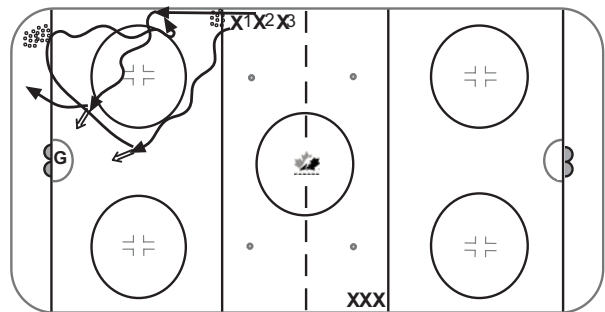



**Drill Name & Description**  
**High Cycle**

- X1 begins with puck, shoots on goal, releases to pick up puck beside net and skates up the wall.
- X2 trails X1 holding high slot and fill in behind in corner.
- X2 receives chip from X1, then drives top of circle for shot and release.
- X3 follows X2 in.

**Key Teaching Points**

- Jump on loose puck after shot.
- Protect puck coming up wall.
- Support play, move to open space and communicate.
- Drive seam.
- \*This drill can be done 4 corners and 4 nets.

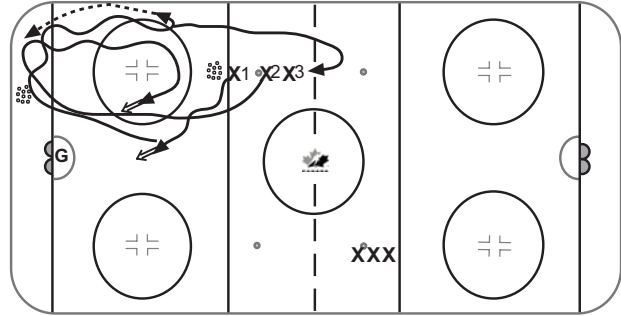

**Drill Name & Description**  
**Low Cycle**

- X1 begins with puck, shoots, returns for 2<sup>nd</sup> puck and carries down wall.
- X2 provides support and communicates.
- X1 protects puck and reverses it to X2 who drives net for a shot.
- X2 retrieves 2<sup>nd</sup> puck and X3 supports.

**Key Teaching Points**

- Drive low down wall protecting puck.
- Support player fills open space and communicates.
- Support player jumps to loose puck and drives net.

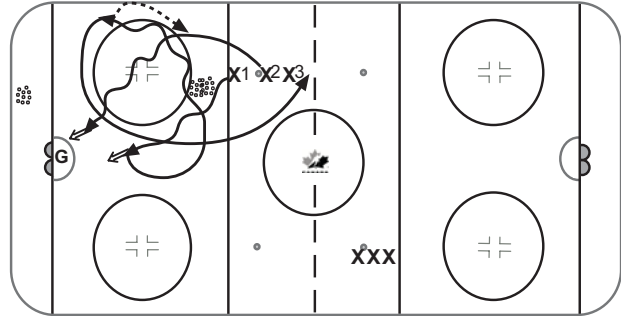

**Drill Name & Description**  
**Back of Net**

- Same as above.
- X1 releases to corner and X2 releases below goal line on near post.
- X2 has the option to come out either side.
- Use net to protect puck.
- X2 then releases for puck and X3 jumps to support.

**Key Teaching Points**

- Protect puck.
- Use net to avoid pressure.
- Communicate.

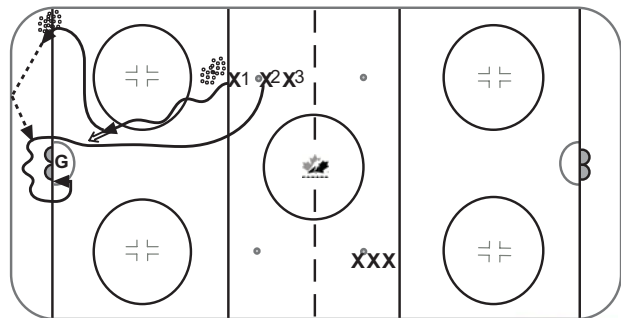



**Drill Name & Description**

**Double Cycle**

- Coach spots pucks to corner where X1, X2, X3 cycle until whistle is blown.
- X's generate scoring chance, then jump on 2<sup>nd</sup> puck spotted by coach.
- Can work on any type of offensive zone play.

**Key Teaching Points**

- Puck carrier protect puck and drive high or low along wall.
- Support should jump to open ice and communicate.
- X3 holds high until puck is moved, then support.
- \*Puck carrier moves and jumps off wall to break coverage and be high.

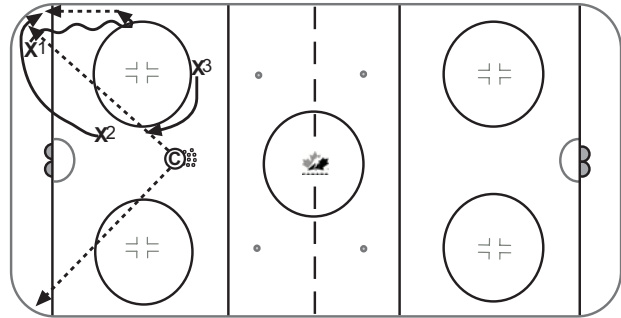

**Drill Name & Description**

**2 End Continuous Cycle**

- X's cycle vs 2 O's playing low.
- 3 other O's are passive at top of circle.
- If O's get puck up to 3 passive O's or Coach blows the whistle and feeds 3 O's a puck, all five O's go down ice, while five X's sprint to players box.
- O's get into position for offensive zone play vs 2 live X's and 3 passive X's.

**Key Teaching Points**

- Five new O's go onto the ice when zone is cleared.
- Variations to this drill can include practice "changing on the fly".

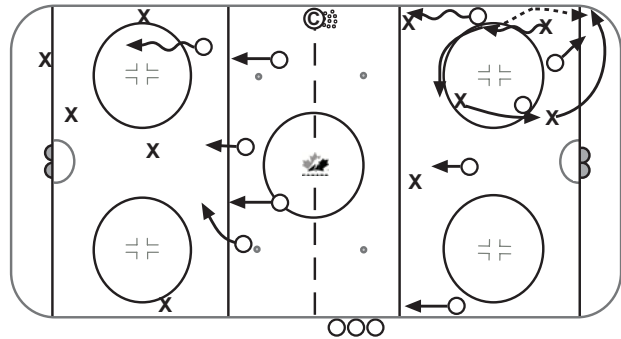

**Key Points**

- Forwards win the race to the puck
- Protect the puck.
- Take puck away from pressure forcing the defensive team to adjust.
- Supporting player fill the open ice and communicate.
- Move the puck to the open ice.
- Move to support the puck carrier.
- Attack seams as they make themselves available.
- Do not throw the puck out blindly.







## INTRODUCTION: SPECIAL TEAMS

### Power Play Breakouts

Regardless of Breakout, no – stop option should be considered to force PK forecheck to make a decision

#### Drill Name & Description

##### Power Play – Breakout - Stretch vs Support

- Stretch when puck carrier is coming your way (ex. F3)
- Support when puck carrier is moving away from you (ex. F2)

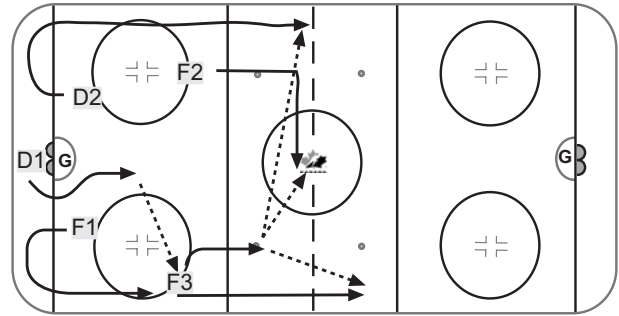

#### Drill Name & Description

##### Power Play – Breakout - Stretch vs Support

- Timing is crucial. Defensemen need to pass early to give forwards the possibility :
  - To keep speed for entry
  - To establish support
  - To be 1<sup>st</sup> on pucks on dumps

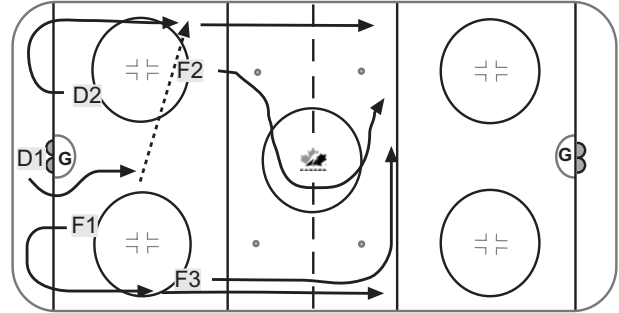

#### Drill Name & Description

##### Power Play – Breakout - Stretch vs Support

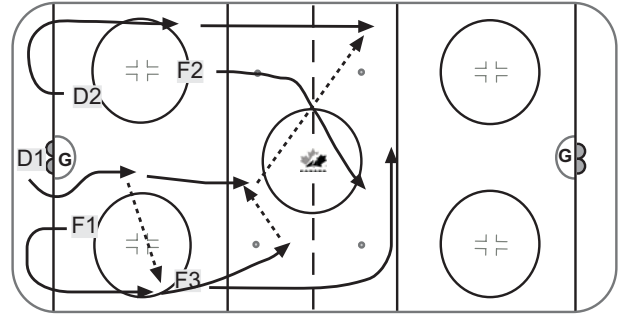



**Drill Name & Description**  
**Power Play – Zone Entry**

- Goal is to keep control on entry
- 4 main target areas to reach while carrying the puck or to place the puck into (to regain puck)

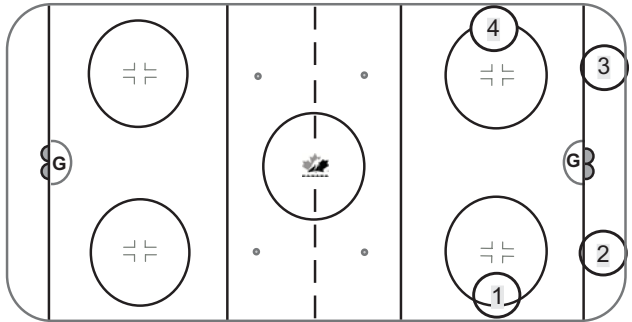

**Drill Name & Description**  
**Power Play – Zone Entry**

- Need 2 players on strong side supporting each other and covering #1 and #2 target areas
- Need 2 players on far side to cover the further target areas (#3 and #4)

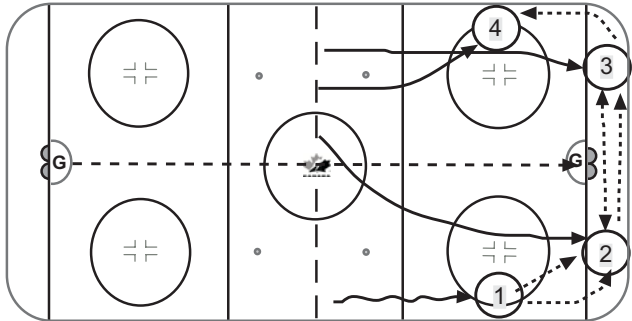

**Drill Name & Description**  
**Power Play – Zone Entry**

- Can use the target areas to:
  - Start set-up
  - Release pressure
  - Create battles

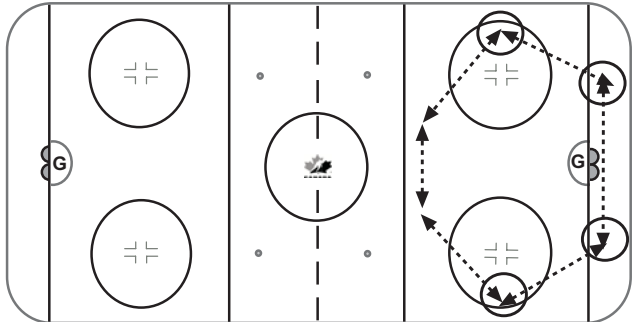



**Drill Name & Description**  
**Power Play – Zone Entry**

- On battles you can keep a player wide as an outlet rather than have 3 on the same side. It allows players in the battle to know where to release the pressure.
- The far man still acts as a forechecker in case the opponent carries puck behind the net.

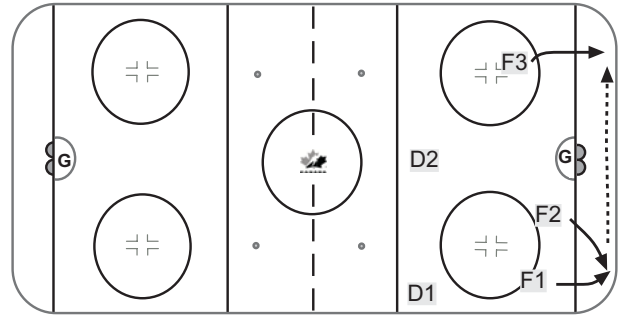

Many set-ups exist and all work well against a particular penalty kill formation. All of them rely on players ability to (a) release pressure, (b) attack seams.

**Drill Name & Description**  
**Power Play – Set Up**

- Many set-ups exist and all work well against a particular penalty kill formation. All of them rely on players ability to (a) release pressure, (b) attack seams.
- Releasing pressure can be accomplished by:
  - Transferring puck across the net (the further out to far corner the better)
  - Quick up to D1 or D2 from goal line (no carrying)

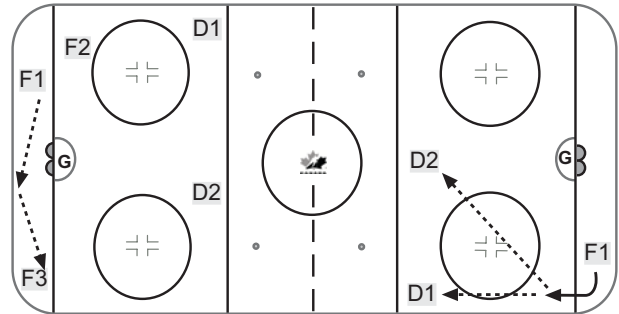

**Drill Name & Description**  
**Power Play – Set Up**

- Carry up real high (to play 2 vs 1 up top)
- D1 slide

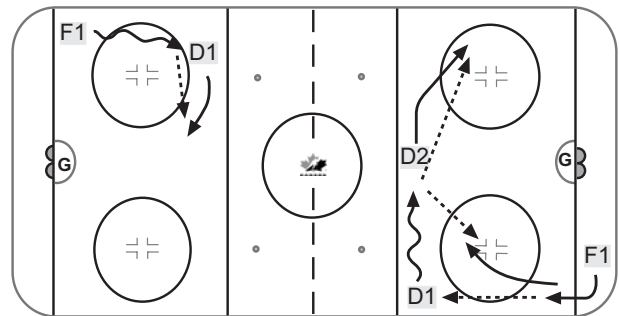



**Drill Name & Description**

**Power Play – Set Up**

- Wide D to D pass

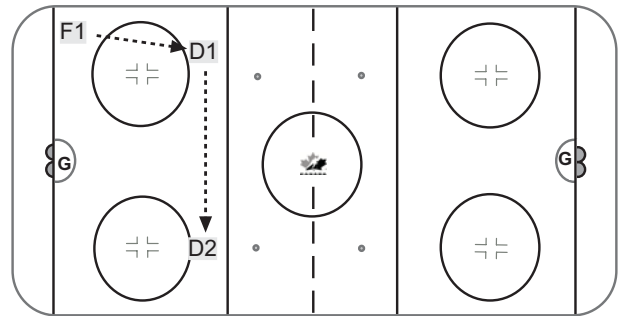

**Drill Name & Description**

**Power Play**

- Attacking seams quickly with:
  - A shot (quick release)
  - A pass (move puck quickly)
  - A carry (move feet)
- Always try to position your body to attack a seam (with or without puck)

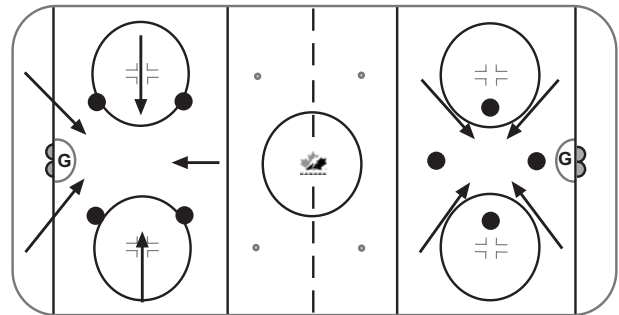

**Drill Name & Description**

**Power Play – Spread (3-2) Set Up**

- Very versatile set-up because it can easily turn into:
  - Overload
  - Umbrella
  - 1-3-1

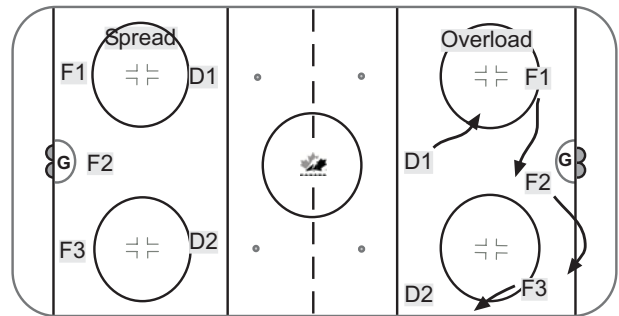



Drill Name & Description
<b>Power Play</b>

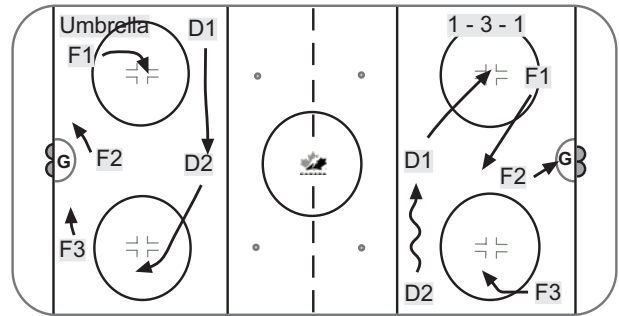

Drill Name & Description
<b>Power Play – Example of 1-3-1</b>
<ul style="list-style-type: none"> <li>• Need very skilled and quick players</li> <li>• Can be dangerous for turnovers</li> <li>• Need middle man to stay high and back to his position when battles occur</li> <li>• Can provide a “4 man jam” on shots</li> </ul>

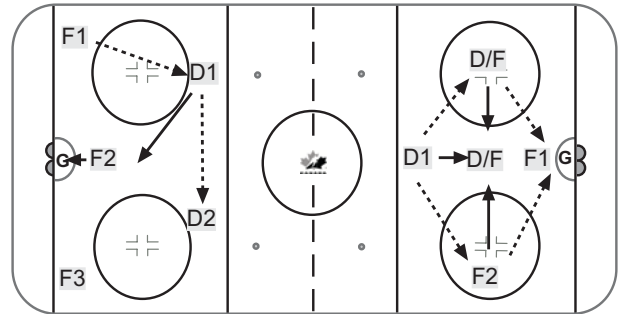

Drill Name & Description
<b>Power Play – Example of 1-3-1</b>
<ul style="list-style-type: none"> <li>• Basic plays (with FWD or DEF filling middle)</li> <li>• Low Support               <ul style="list-style-type: none"> <li>○ Walk in</li> <li>○ Slot pass</li> <li>○ Back door</li> </ul> </li> <li>• High Support</li> </ul>

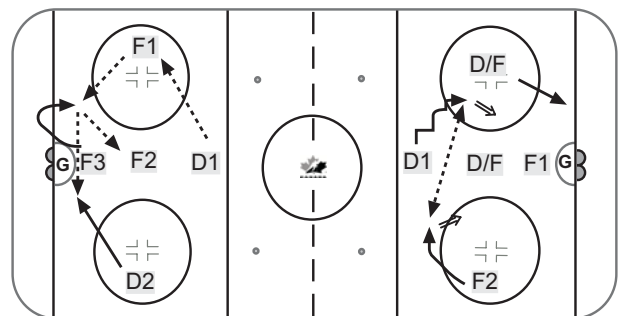



Drill Name & Description
<b>Power Play – Example of 1-3-1</b>
<ul style="list-style-type: none"> <li>• Behind the net plays</li> <li>• 2 man cycle</li> </ul>

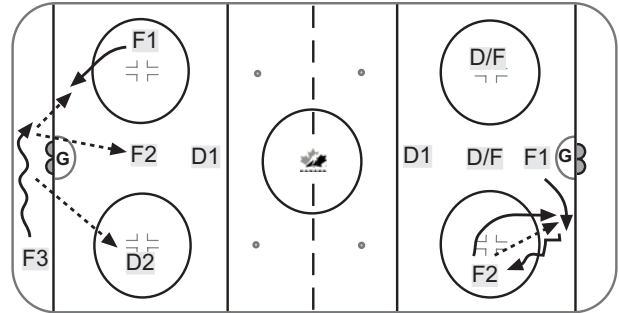

**Power Play Drills**

Drill Name & Description
<b>Power Play – Breakout and Entry</b>
<ul style="list-style-type: none"> <li>• Practice:             <ul style="list-style-type: none"> <li>○ Early pass</li> <li>○ Stretch vs support</li> <li>○ Entering 2 vs 1</li> <li>○ Using target areas</li> </ul> </li> </ul>

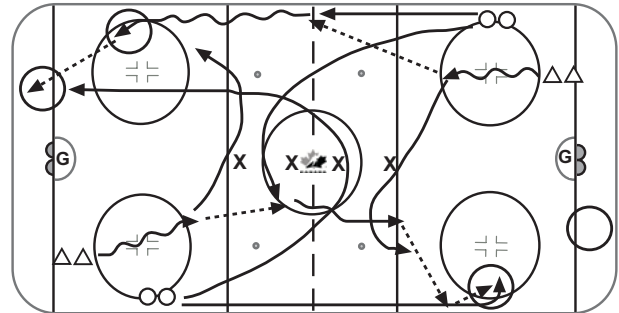

Drill Name & Description
<b>Power Play</b>
<ul style="list-style-type: none"> <li>• Practice releasing pressure (5 on 3 for 30 seconds)             <ul style="list-style-type: none"> <li>○ Rims (short and long)</li> <li>○ Look</li> <li>○ Protect puck</li> </ul> </li> <li>• Only play along the boards, 3 defenders just put heavy pressure</li> </ul>

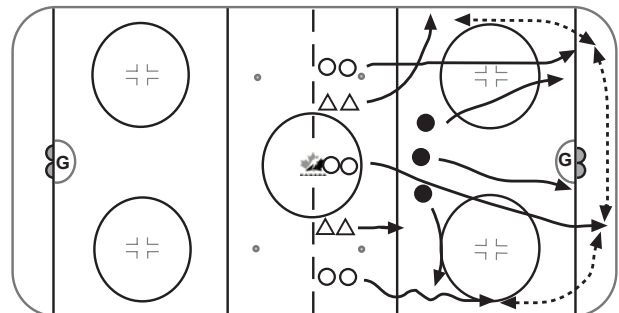





**Drill Name & Description**  
**Power Play**

- Practice 2 vs 1 (up top)
  - Defender tries to prevent D's shot and walk in until offensive players have success
- Can make it a competition

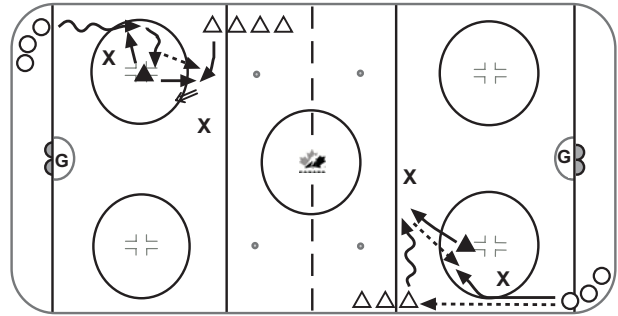

**Drill Name & Description**  
**Power Play**

- 4 vs 2 from behind the net
- For 30 seconds, get a new puck for every whistle.

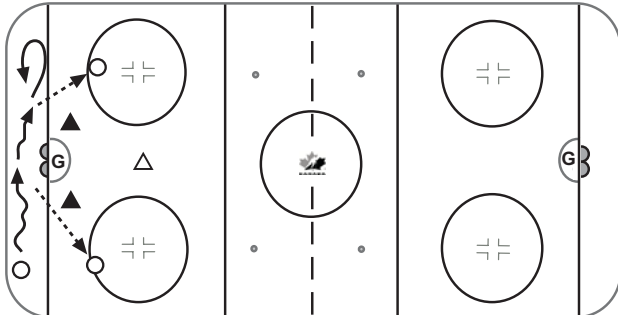

**Drill Name & Description**  
**Power Play**

- 3 vs 2 (on side)
- 4 vs 2 down low
- 2 defenders block options and 4 power play players choose options

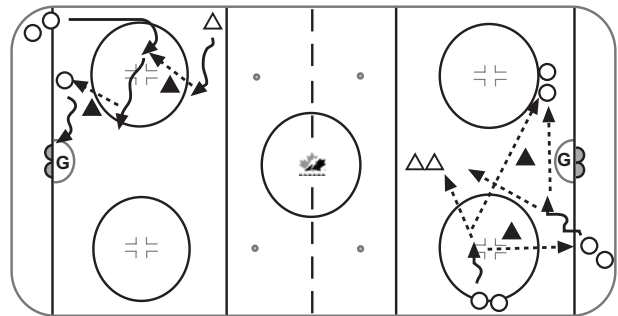



**Drill Name & Description**

**Power Play**

- 4 vs 2 up top to practice positioning body in seams with or without the puck
- Shoot on whistle

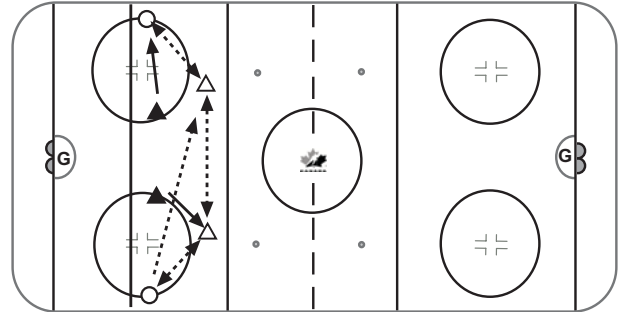

**Drill Name & Description**

**Power Play**

- Practice only passing for 1 minute with 2 pucks at the same time (1 second possession)
- It will increase vision, speed of execution, and communication

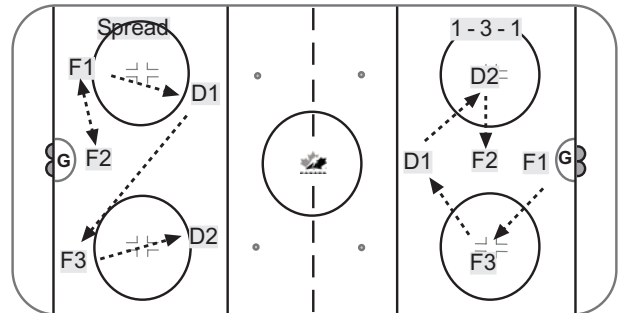



### Penalty Killing Forechecks

**Drill Name & Description**

**Penalty Killing – 1-3 Forecheck**

- F1 steers play to one side, then sprints back to support once puck is moved

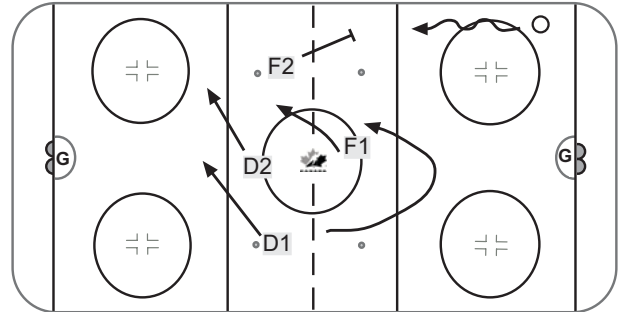

**Drill Name & Description**

**Penalty Killing – 1-3 Forecheck**

- F2 or D1 stand up rush, not allowing opposition to enter zone with control of puck.

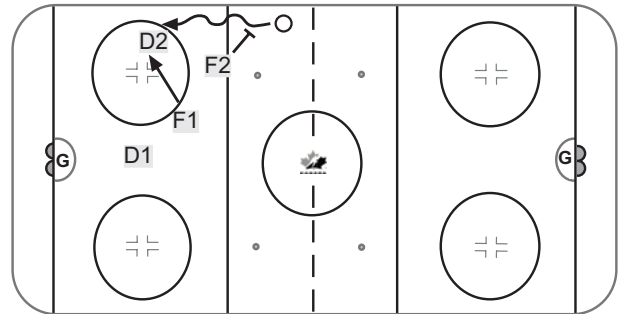

**Drill Name & Description**

**Penalty Killing – 1-3 Forecheck**

- D2 is aggressive and ready to (a) retrieve chip or dump, or (b) pressure puck carrier immediately should he beat F2 or D1. F2 or D1 are in support, F1 supporting through middle also.
- Upon retrieval of puck, F2 or D1 must be prepared and available to release as an outlet for D2 who has retrieved puck, should he not have an opportunity to clear it himself.

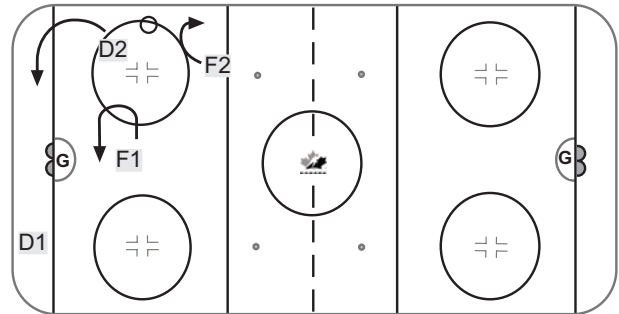



**Drill Name & Description**  
**Penalty Killing – DZ vs Overload**

- Key is to take away time and space. Good players will make good plays if they have the time to make them. Force them to make a great play to beat you.

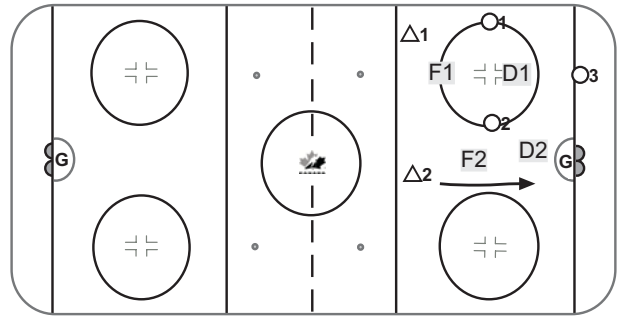

**Drill Name & Description**  
**Penalty Killing - DZ vs Overload**

- F1 must not allow defencemen to walk blueline with puck. If D walks, we lose pressure. F1 must attack D hard and force play back down to half wall.

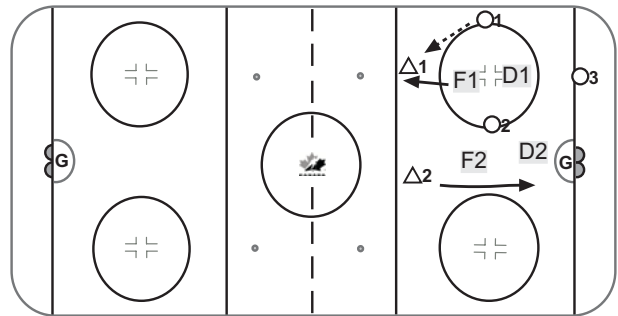

**Drill Name & Description**  
**Penalty Killing - DZ vs Overload**

- If opposing F on half wall is above top of circle, F1 must try to press him down the boards, not allowing a pass back to the D at point. If half wall forward receives pass below top of circle, D1 should be in good position to jump and pressure. D2 is cheating to pressure low play. F2 covers net front.

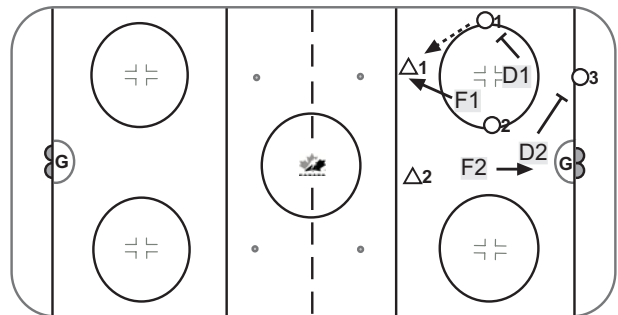



**Drill Name & Description**  
**Penalty Killing - DZ vs Overload**

- Key to this PK is when opponent gets set up with full control on half wall. D1 must contain, maintain positioning in shooting lane and inside the dots.

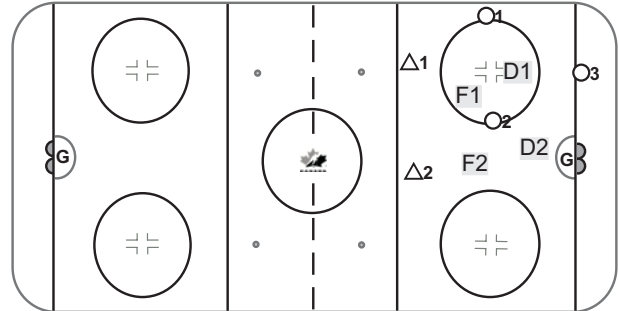

**Drill Name & Description**  
**Penalty Killing - DZ vs Overload**

- The low play is now imperative. If low opposing F is outside dots when low play is made, D1 plays the 2 on 1 and continues to contain as low F is not a threat.

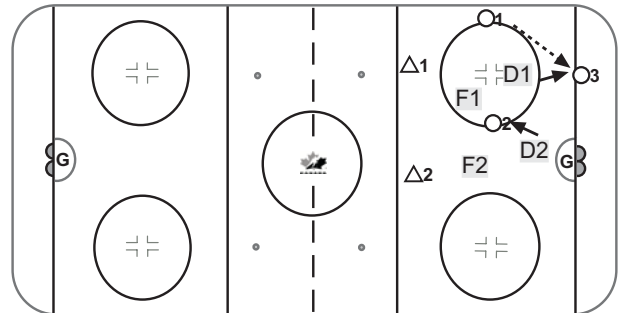

**Drill Name & Description**  
**Penalty Killing - DZ vs Overload**

- If low F is in lane or inside dots when low play is made, full court press is on. D2, who is initially positioned on the near post a stick length from opposing F in slot, immediately attacks low F all out with stick on puck. This denies a pass to slot F or backside D who is covered by F2 collapsing to net front.

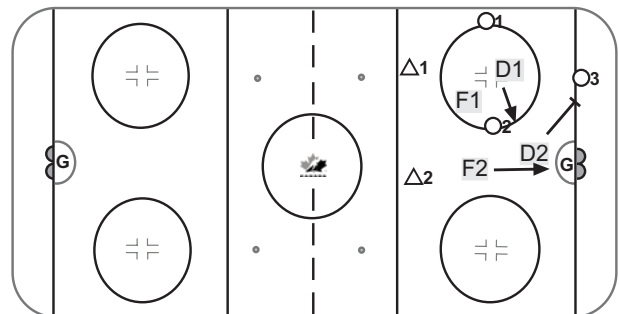



**Drill Name & Description**  
**Penalty Killing - DZ vs Overload**

- When pass is made low, D1 must immediately get back towards net front and get his stick in the passing lane from low F to slot forward to deny a quick pass to the slot.

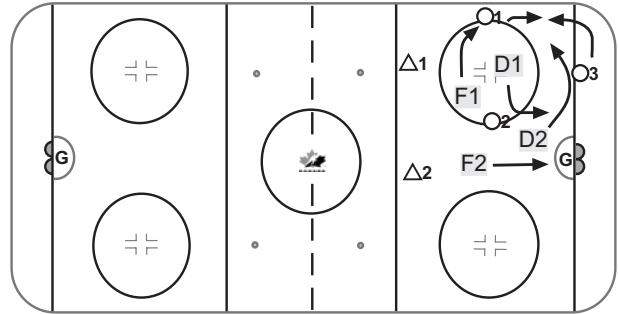

**Drill Name & Description**  
**Penalty Killing - DZ vs Overload**

- Once pass to slot has been denied, D1 now cheats to corner in support of D2, who should be pressing low forward to the boards. D1 is ready to attack puck if it is cycled. F1 is in position to deny pass to point and deny a walk off the boards. F2 is covering net front and aware of weakside D at all times.
- When executed correctly, this kill is very effective at creating a battle and a turnover.

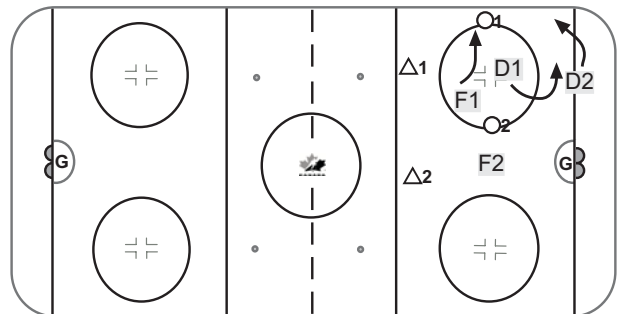





## **INTRODUCTION: GOALTENDING**

### **Skating Drills**

To be a good goaltender you must be an efficient skater. Your goaltender does not necessarily have to be the fastest skater on the team, but the best in terms of control and mobility. Pushes from post to post and ability to get quickly to plays laterally are essential for goalies to be able to perform at a high level.

Goaltenders must learn to push with strength and stop hard when needed. So when doing T-push or shuffle drills I suggest everything is done in sequence. Example: A coach should be calling out for the goalie to PUSH----STOP----PUSH----STOP-----PUSH----STOP etc. giving one second in between pushes. This will give the goaltender time to recover and will keep him from developing bad habits by doing the drill too fast.

The ability for a goaltender to change directions quickly is also an absolute must as today's game is a lot about trying to create a situation to get a goaltender moving in the wrong direction. In order to do this, and be effective, skating drills are a natural part of goaltender development.





**Drill Name & Description**

**Letter Drills "T"**

- Goaltender starts in middle of the net.
- T-push to just above the crease, stop.
- T-push to outside, stop, and back.
- Emphasize stopping with outside foot to create proper transition.

**Key Teaching Points**

- Knee bend.
- Outside leg stop.
- Balance.

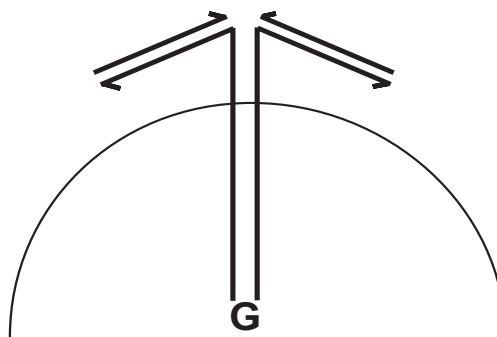

**Drill Name & Description**

**Letter Drills "U"**

- Goaltender starts at top of the crease, t-push to post.
- Shuffle post to post.
- Forward t-push to top.
- Repeat.
- Variation can include butterfly slide post to post.

**Key Teaching Points**

- Staying in stance.
- Hands in front of body.
- Proper use of c-cuts.

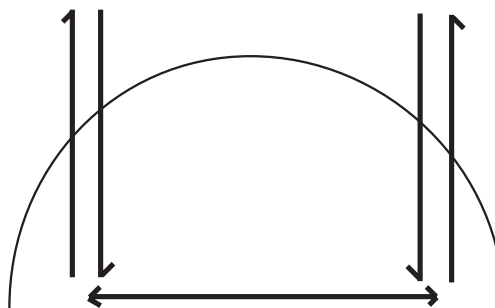

**Drill Name & Description**

**Letter Drills "V"**

- Goaltender starts in the middle of the net.
- T-push at about 45 degrees to top of the crease.
- Stop with outside leg.
- Turn and T-push back to middle, reposition and repeat to other side.

**Key Teaching Points**

- Lead movement with hands, keep head up.
- Stopping with proper leg, body rotation.

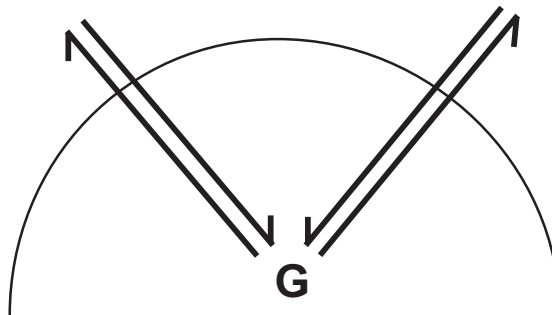



**Drill Name & Description**

**Letter Drills "W"**

- Goaltender starts outside of left side of crease.
- Backward c-cut to post.
- T-push to middle.
- T-push to post.
- Forward c-cut out.
- Repeat back.

**Key Teaching Points**

- Lead with stick.
- Keep square position.
- Head leads all movement.

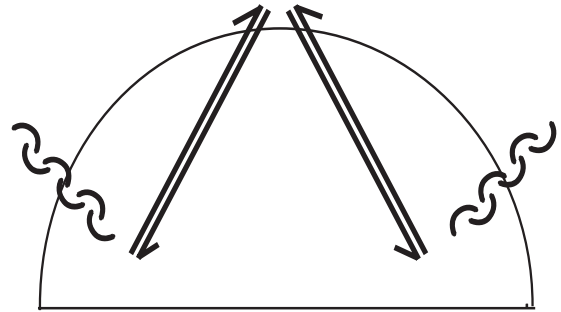

**Drill Name & Description**

**Letter Drills "X"**

- Goaltender begins on post.
- Shuffle post to post.
- T-push across crease and stop with inside leg.
- Rotate and T-push back to previous post.
- Repeat.

**Key Teaching Points**

- Must stop with outside foot at all times.
- Lead with hands.
- Look at target position.
- Always top on leg that is closest to middle of net to maximize coverage.

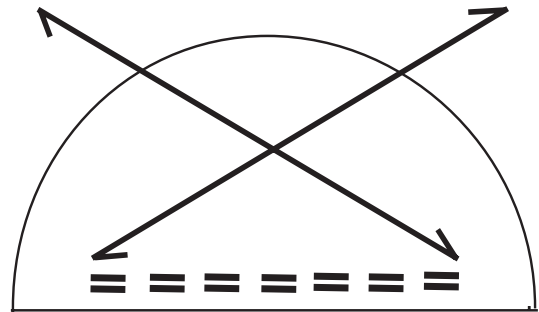

**Drill Name & Description**

**Letter Drills "Y"**

- Goaltender begins at post, T-pushes to top of crease, stops.
- Goaltender c-cuts forward two strides, stops.
- C-cut back two strides and open pivot to shuffle back to other post.
- Variations will have shot coming from either side during shuffle to post.

**Key Teaching Points**

- Rigid starts and stops.
- Proper pivots.
- C-cuts must be quick.

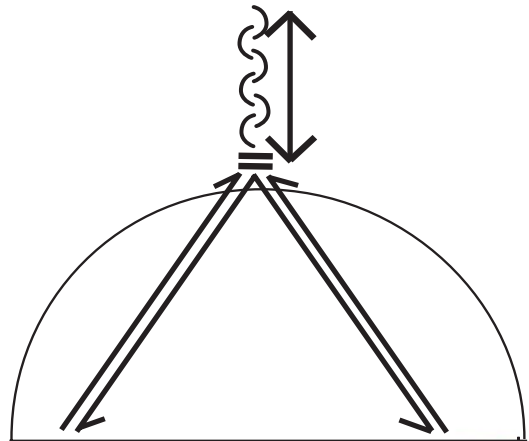



**Drill Name & Description**

**Letter Drills "Z"**

- Goaltender starts on either post.
- Shuffle post to post.
- T-push across crease and stop with inside leg.
- Shuffle across top of crease and then continue in reverse.

**Key Teaching Points**

- Be sure goaltender shuffles across.
- Locate target before moving.
- Hard pushes and strong stops.

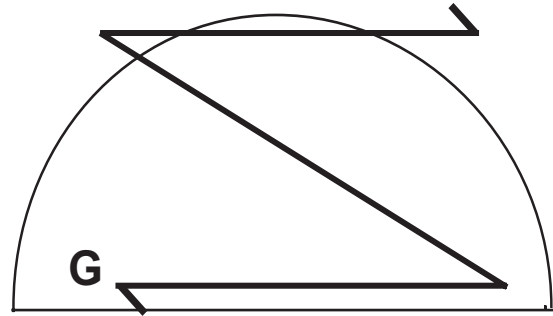

**Drill Name & Description**

**Half Net 3 Position Drill**

- Goaltender starts on post.
- Steps out to all three positions and back to post in 1, 2, 3, 2, 1 order.
- Repeat three times per goaltender.

**Key Teaching Points**

- Back up from positions 1 and 2.
- T-push back from 3.

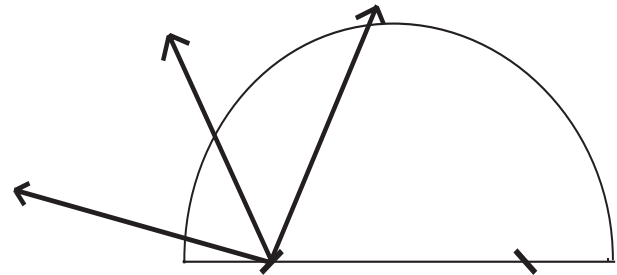

**Drill Name & Description**

**T-Push / Butterfly Slide Drill**

- Goaltender starts on post, T-push across crease and stop with inside foot.
- Butterfly slide to middle and recover.
- Pivot and T-Push to opposite post and repeat other direction.

**Key Teaching Points**

- Stop with inside leg.
- Butterfly slide must be quick to middle.
- Deep knee bend.

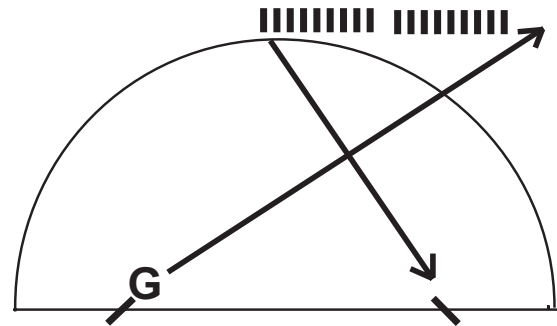



**Drill Name & Description**

**5 Puck Movement Drill**

- Goaltender starts in the middle of the net.
- Does the five points in order first time through.
- Second time through a coach will call out the numbers to goaltender.
- Goaltender will do drill twice.

**Key Teaching Points**

- Always start in the middle of the net.
- Eyes on the target.
- Deep knee bend.
- Quick feet.

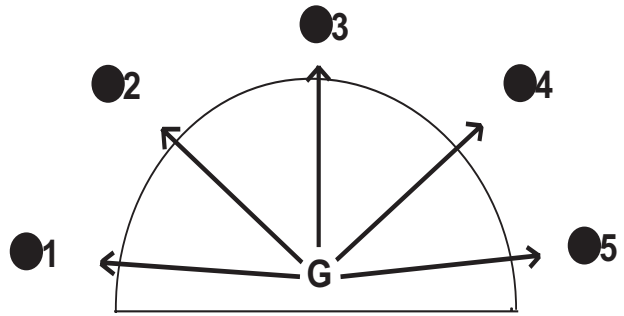

**Drill Name & Description**

**Butterfly Slide Transition**

- Goaltender starts on post.
- T-Push to top middle of crease.
- Butterfly slide back diagonally.
- Push outside leg up quickly and butterfly slide to middle of net.
- Inside knee should not leave the ice.

**Key Teaching Points**

- Be sure to hold butterfly position throughout.
- Do not lift inside leg.
- Timing.

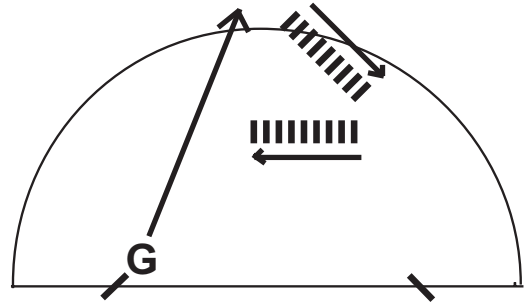

**Drill Name & Description**

**3 Position T-Push**

- Goaltender starts on post.
- Push out to position 1, stop with outside leg and c-cut back.
- T-Push to top of crease and T-push back.
- Shuffle to far post and back.

**Key Teaching Points**

- Proper stance position.
- Looking at target.

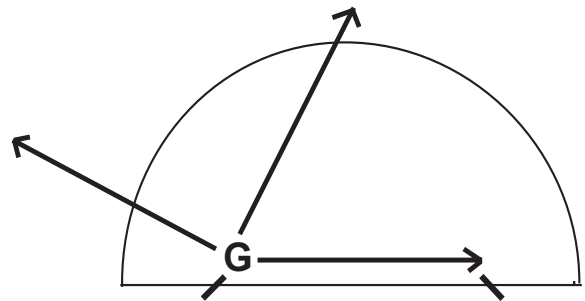



**Drill Name & Description**

**3 Position Full Net**

- Goaltender starts in middle of net for each position.
- T-push out and back to positions 1 and 3.
- C-cut out and back for position 2.

**Key Teaching Points**

- Proper stance position.
- Looking at target, quick feet.

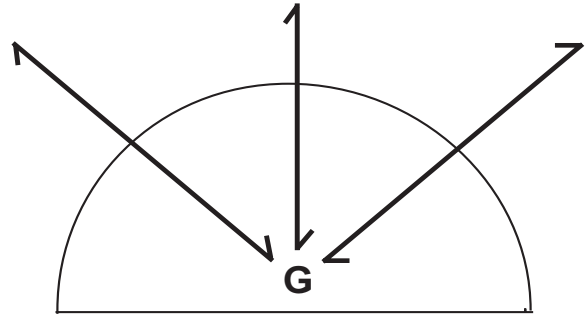

**Drill Name & Description**

**Skating Drill – Zig-Zag**

- G starts at post.
- Line up staggered cones at least 3-4 feet apart.
- Does zig-zag forwards to cones, then backwards by using t-push, shuffle, or powerslide maneuver.

**Key Teaching Points**

- When doing drills using T-push or shuffle there should be no head bobbing up and down.
- Smooth lines with hard pushes.

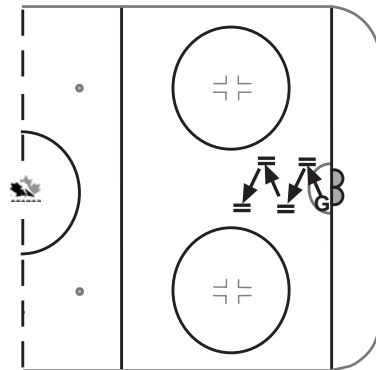





## **Butterfly Save and Butterfly Slides**

Goaltending has evolved in the past 10-15 years mostly because of the advancement of the butterfly save. The equipment that goaltenders wear today is much more protective than that of the past and allows the goaltender the ability to drop into the butterfly save without risk of injury. Since the majority of shots are low and on the ice, the butterfly save is the most effective tool at stopping the puck, while maintaining the ability to stay in control.

When dropping into the butterfly there are a number of technical components that allow a goaltender to cover a vast majority of the ice. A goaltender should have good inner knee protection, and wear their pads quite loosely as this will allow the pad to turn on its side, with the inner knee resting on the knee pads. The goaltender is then trying to create a wall with the goalie pad and maximize coverage on the ice. The chest should be upright and the goaltender should be leaning slightly forward. A goaltender that falls backwards and ends up on their back will not be effective. The goaltenders stick should be about 1-2 inches away from the pads on the ice, slightly angled towards them, and should be moved as little as possible in order to not open any holes between the legs.

When taking a shot to the chest a goaltender should be aware to never move their hands in front of their chest before the puck makes contact as this will cause a huge rebound. They should always take the puck into the chest as this will cushion the shot and deaden the rebound, allowing the goaltender to cover the puck.

\*A goaltender should remember to stay on their feet as long as they can and only drop into the butterfly when the shot has been taken. Even though the butterfly has become the most effective way to stop the puck, a goaltender should never drop to their knees early. This opens up holes and will put a goaltender at the mercy of the shooter. The best goaltenders in the world are the most patient ones, allowing the player to make the first move and not opening up before the shot is taken. Patience is still and always will be the golden rule of goaltending.





**Drill Name & Description**  
**Butterfly Drill**

- Pucks in middle, G fronts player from top of crease in middle.
- Pass to players at tops of circles.
- No one timers-stop pass and shoot low shots.
- G butterfly save.

Key Teaching Points:

- G must shuffle or T-push to get to shooter.
- Good hip rotation with strong push.
- Follow rebound.
- Idea is to get goalie set in stance for shot.

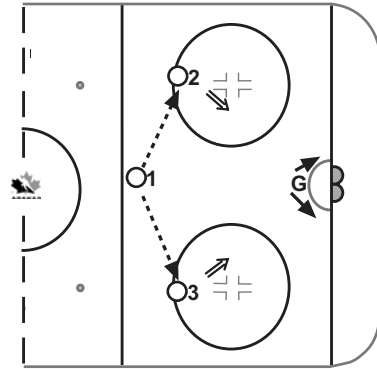

**Drill Name & Description**  
**Butterfly Drill with Movement**

- G starts on post.
- T-push to top of crease.
- Shot from angle.
- Do each post and go corner / middle / far side.
- Do one area at a time, 10 shots each area, 10 pushes.

Key Teaching Points

- Strong pushes.
- Get to top of crease and set.
- Good butterfly, chest up, stick on ice, follow rebound.

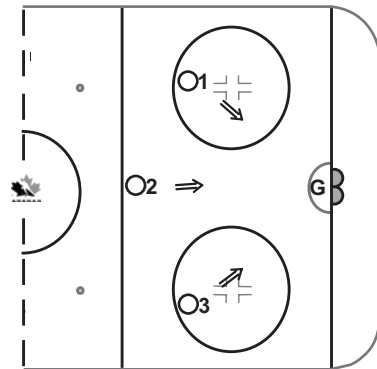

**Drill Name & Description**  
**Simple Butterfly Drill (follow rebound-warm-up)**

- Shots from all angles on ice (one area at a time, one shot at a time).
- G butterflies to make save.
- Minimum 10 shots from every angle.
- Goalie follows their rebound and resets.
- Goalie starts from stationary position.

Key Teaching Points

- Proper butterfly.
- Chest up.
- Following rebound.

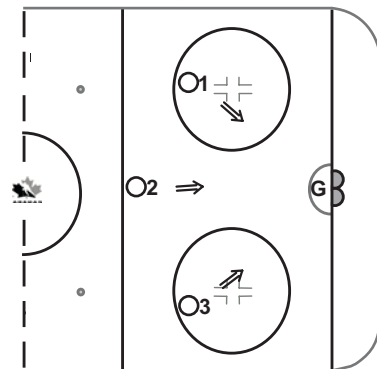



**Drill Name & Description**

**Butterfly Slide Development**

- G starts on top of crease facing dot.
- G will execute five sets of five butterfly slides.
- Set 1: One ice lead pad.
- Set 2: Into body as body comes through space.
- Set 3: Quick jam with spread off of slide.
- Set 4: Slide with comeback and spread opposite way.
- Set 5: Butterfly slide into anything (jam, spread, reaction, etc).

**Key Teaching Points**

- The objective of this drill is to allow G to work on butterfly slide mechanics, understand that the slide is a lateral move and not a save movement.
- Mechanics must be rock solid...this is not about speed.
- Butterfly slides require an opening to the new puck position – as always this is accomplished with a visual lead.
- Like the backside push, butterfly slide mechanics include: visual lead, rotation, gather and extend.

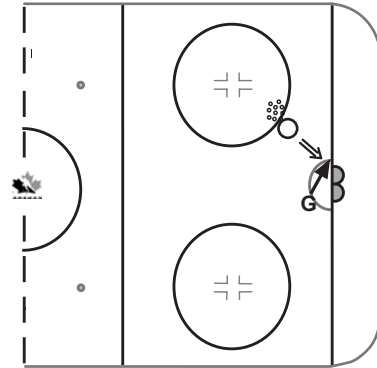

**Drill Name & Description**

**Lateral Feeds #1**

- G starts facing high.
- Pass to low backdoor.
- G must rotate and T-push into a butterfly slide.
- Change sides.

**Key Teaching Points**

- G must be aware of the dangerous player.
- Goalie should start with toes at top of crease.
- Goalie will retreat to a Lower depth position backing off slightly.

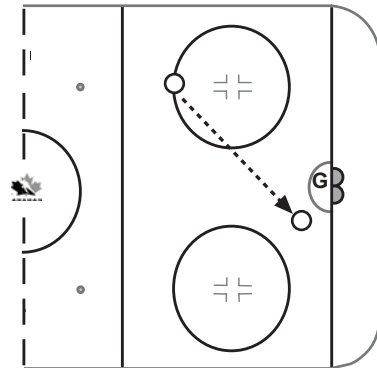



**Drill Name & Description**

**Lateral Feeds #2**

- O1 passes to O2 behind net.
- O2 passes to O3 at the top of circle.
- G must get off post and front O3 with toes at a minimum top of the crease.
- O3 passes down low to O1 who is at back door.
- Goalie moves to lower depth position and have slight backwards flow.
- Goalie uses butterfly slide to make save.

**Key Teaching Points**

- Goalie must be careful not to over slide.
- Goalie must keep stick between five hole not creating an opening.
- Goalie must have a strong push to get across.

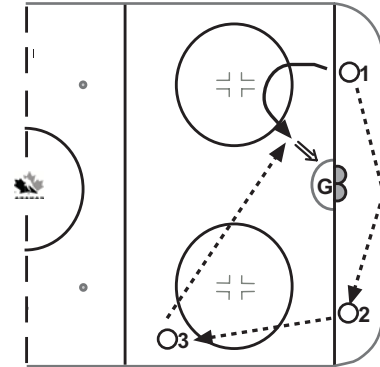



## **Scramble Tactics and Powerslides**

Scramble tactics are involved anytime there is a rebound or a quick change of direction is needed for a goaltender. In past situations a goaltender was very much at the mercy of the player in a scramble, having to resort to diving or flopping around. With the powerslide and newly created ways of scramble tactics for today's modern goaltender, a goalie is easily able to move quickly around his crease without ever having to get off of his knees. This results in always being in a square position with the shooter even in a rebound, or battle situation.

To explain the powerslide, it is a technique in which a goaltender has dropped into a butterfly and wants to move quickly without getting up. In order to do this, the goaltender will leave one knee on the ice and take one knee off. It is actually only getting half way up, or picture it as leaning on one knee with the other bent in a 90 degree position. The blade of the skate on the bent knee will be the one used for mobility. The goaltender will use the toe of the blade to push himself from side to side. The knee which is on the ice will be resting on the inside knee pad and the pad itself will be on its side, with the inside roll of the pad on the ice. The face of the pad should not be on the ice, as having it on its side will build a wall with the goalie pad, and allow the ability to slide. To perform this movement efficiently a goaltender must wear his pads quite loosely. The chest should be upright and the goaltender should always have his body weight forward, never leaning back.

If this maneuver is used effectively it gives the goaltender a unique advantage in a scramble situation. The goaltender will rarely be caught out of position and will be able to change direction quickly if needed. A goaltender wants to avoid falling backwards at all costs and this is an effective tool to in keeping a forward body position.





**Drill Name & Description**

**Post Save Up**

- On “Go”, low shot far side and G drops into butterfly.
- G power slide in butterfly to middle and G gains feet.
- Shot back to same side low.
- G makes save, follows rebound using slide back into starting position and regains feet.

**Key Teaching Points**

- Goalie must learn to recover properly.
- Goalie must move efficiently in a scramble.

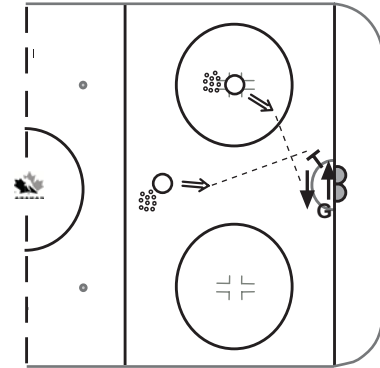

**Drill Name & Description**

**Post Save Down**

- G starts on feet.
- Shot to far post.
- G power slides to middle and gains feet.
- Low shot back to side he came from.
- Power slide back to initial position.
- 3<sup>rd</sup> shot look to score.

**Key Teaching Points**

- Proper recovery.
- Always staying forward never falling backwards.

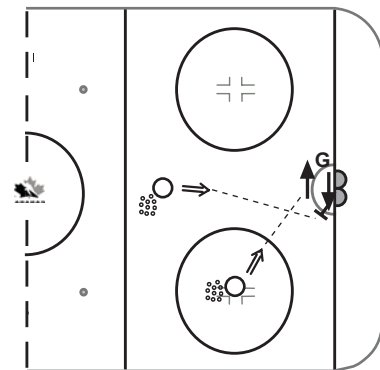

**Drill Name & Description**

**Scramble Tactics & Rebound**

- O1 shoots low far side.
- O2 shoots then shoots a set rebound.
- O2 skates behind net after shooting, picks up set puck and tries stuff play on the other side of net.
- After O1 shoots G has to either use powerslide, or get up on feet to get from shooter O1 to shooter O2 then has to scramble back to post for stuff play.

**Key Teaching Points**

- Low ice coverage.
- Strong pushes.
- Leading with hands.

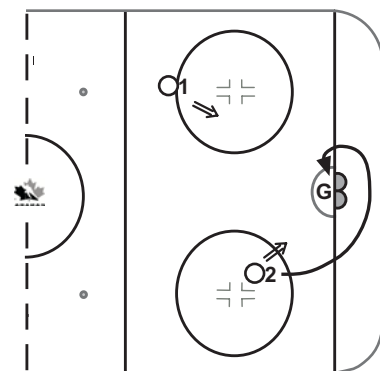





**Drill Name & Description**

**Wrap-Rebound**

- G starts at same post as shooter O1 and follows wrap attempt from beginning.
- O1 wraps, O2 skates into set puck and shoots.
- G can use VH or paddle down on wrap attempt.
- G must use scramble tactics to get to second shooter.

**Key Teaching Points**

- Good low coverage.
- Strong push and hip rotation.

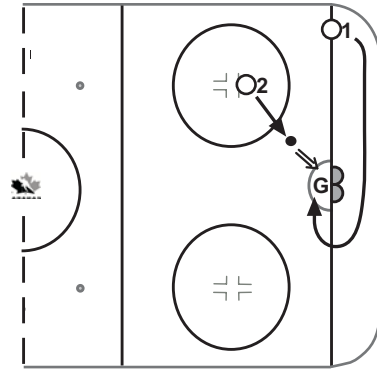

**Drill Name & Description**

**Double Rebound**

- Shooter shoots low shot from slot at the goalie's right foot.
- O2 who is on the right side skates into set puck and shoots.
- G must use power slide to get to shooter O2.
- After O2 shoots, G must use power slide to get to O3 who skates into set puck to shoot.

**Key Teaching Points**

- Lead with hands.
- Good low ice coverage.
- Strong pushes.
- Battle mindset.

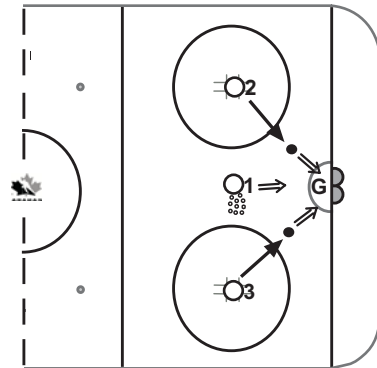

**Drill Name & Description**

**Scramble Tactics & Rebound**

- O1 shoots low farside.
- O2 shoots set puck rebound from middle.
- G saves first shot in butterfly, then power slides across to make rebound save.
- Phase 2: put O2 rebound shooter towards back post making the goalie have to move further for rebound shot.

**Key Teaching Points**

- Good hip rotation.
- Lead with glove and stick.
- Need proper spacing between shots.

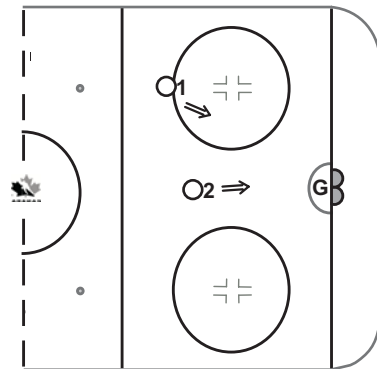



**Drill Name & Description**

**Side to Side Slide**

- Continual shorts from slot on ice at posts.
- G moves side to side in butterfly position using backside slide move.
- Do approx. 5-10 reps per side.
- G must never stop moving or come off knees.

**Key Teaching Points**

- Strong pushes.
- Low on-ice coverage.
- Leading with hands-with good hip rotation.

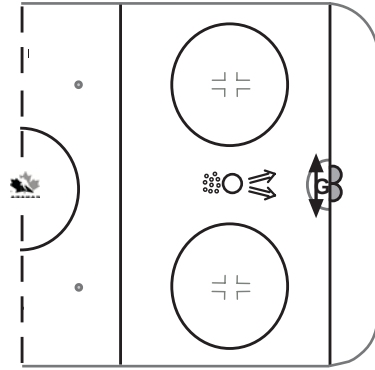

**Drill Name & Description**

**Power Slide or Backside Push Development**

- G starts on top of the crease and on "Go" will rotate and drive laterally towards O1.
- Once G makes initial save, G will rotate and come back to the center to face a shot from O2.
- Once G makes second save on O2, G will rotate a third time and push to the far side to face a shot from O3.
- O1, O2 and O3 should allow G to come into the space each repetition and time their shots so that G is entering the space at the same time as the puck (mix up shots low to the pads and up on the body).

**Key Teaching Points**

- The backside push requires a visual lead, correct rotation, and a strong push.
- Regardless of distance, G should have proper backside push mechanics.
- Flawed mechanics will result in G coming up short.
- Once extended, G should bring himself back together.
- Head and eyes should be controlled and balanced throughout the backside push execution.

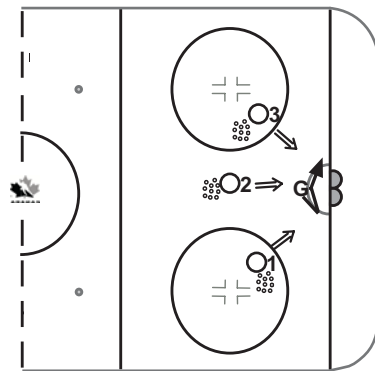



## Pass Out Tactics and Net Drives

One of the most dangerous plays in hockey for a goaltender is when an opposing player has the puck behind the net as it is difficult to see and difficult to follow. **\*When trying to find the puck behind the net, your goaltender must play in a deep crouch in order to take away any quick low plays or shots to the bottom of the net.**

There are a few ways to play situations such as these. In one instance a goaltender may put one foot planted against either post with inside pad lying in a horizontal position. This is called one of two terms, the VH or the one pad down. It is similar to a half butterfly and allows your goaltender to be mobile in the half butterfly position by using a powerslide if needed. It can also take away any stuffs or wraparounds that can be dangerous. Another option is to use the paddle down on either side to avoid any scoring chance from stuffs or wraps.

When the puck is behind the net, the goaltender can use a variety of options to see. Some goaltenders are left shoulder dominant and may like to sit on their right post. This allows them to always be looking over their left shoulder while maintaining one position. It helps the goaltender avoid moving around too much and losing sight of the puck.

The other way to see the puck is by looking through “windows”. This meaning that there are four areas behind the net. If the player is in area 1 or 4, the puck being closer to the corners, the goaltender is on either post. If the player is in area 2 or 3 directly behind the net, the goaltender will be slightly off either post looking over their shoulders through the net. Also a good rule of thumb for a goaltender is to never take your eye off the puck when it is behind the net.





An absolute essential move for a goaltender in any passout situation is that they must get off of their post once the pass has been made to the slot or any higher position. If your goaltender sits back in their net it allows too much net for a player to shoot at. In certain situations a goaltender may not have time to react, so moving forward will take away more net and allow the goaltender to be in a “blocking” situation. The goaltender must remember not to drop the glove and allow room for the player to put the puck up into the top of the net.

**Drill Name & Description**

**High Wrap Drill, Step Out**

- Player passes behind net to opposite player who takes pass and goes around behind net.
- He then steps out from behind net and goes around cone to shoot.
- G must follow player and get off post.

**Key Teaching Points**

- G must have good initial low coverage.
- G must get off of post and adjust their depth so as to not lose coverage for the top of the net.
- G should avoid drifting at shooter.
- Should be push off post and stop at top of crease.

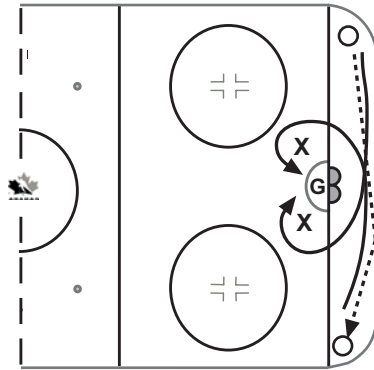



**Drill Name & Description**

**Zone Awareness**

- O1 starts drill by passing to O2 on the half wall.
- O2 begins to walk low in to the zone towards the pylons – O1 is patient up top during O2's selection.
- O2 has three lane options (low slot – cut under first pylon, goal line – cut under second pylon, board – cut under third pylon) and selects one of them.
- If O2 selects a low slot lane, he drives the net and makes a play on the net; if O2 selects a goal line lane then O1 reads this and jumps backdoor (O2 can pass or shoot); if O2 selects a board lane then O1 jumps down on the nearside and looks for a pass from either side of the net.
- Repeat on both sides.

**Key Teaching Points**

- Zone awareness provides the goaltender with simple rules of thumb for their post positioning.
- When the goal line is attacked by a puck carrier, VH is the preferred method.
- When the board lane is attacked, G must stay on their feet to track the puck effectively.
- When the low slot line is attacked, G will tend to separate from the post and square up before responding to the play.
- Nearside passouts will be handled with a depth move by getting off the post.
- All plays, regardless of type or position, require a visual lead.

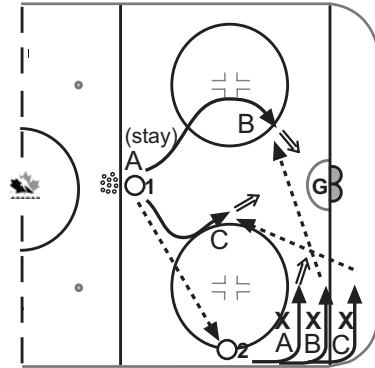



**Drill Name & Description**

**Net Tactics #1**

- Pass behind net O1 to O2.
- O2 walks to nearside post.
- G drops into VH as O2 tries to stuff nearside.
- Switch sides.

**Key Teaching Points**

- Stay low.
- Don't drop into VH too early.
- Low ice coverage is essential.

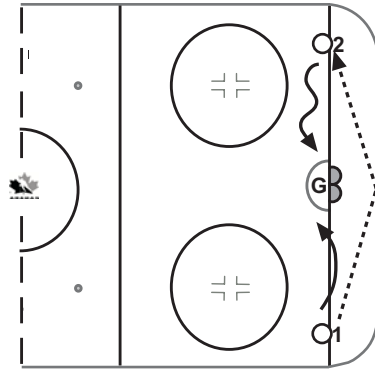

**Drill Name & Description**

**Net Tactics #2**

- Far side wraps, O1 shoots short side shot.
- O2 picks up puck, skates around behind net, wraps puck.
- Repeat Same drill, but player can take 1 step above goal line or wrap.

**Key Teaching Points**

- Goalie must push hard to get to post.
- Low ice coverage is essential.
- Getting up quickly is crucial.

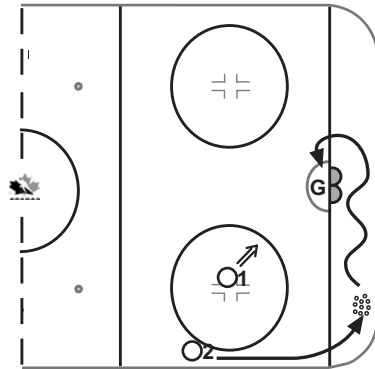

**Drill Name & Description**

**Net Tactics #3**

- O1 dumps, gets his own dump, and passes behind net to O2.
- O1 comes back to front of net and gets pass from O2.
- Goalie uses butterfly slide tactic to make save.
- Repeat.

**Key Teaching Points**

- Strong post to post pushes.
- Good-low on ice coverage.
- Good stick position preventing pass through crease.

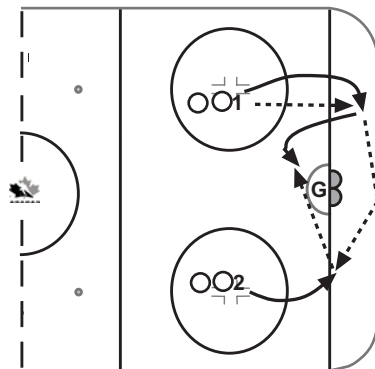





**Drill Name & Description**

**Pass Out Tactics**

- Coach dumps puck into the corner and O1 retrieves.
- O1 on retrieval has two options, to swing towards the net or to swing towards the corner.
- O2 delays and reads O1's directions, if O1 swings to the net O2 stays on the nearside and receives the pass; if O1 swings to the corner O2 jumps to the back door and receives the pass.
- Phase 1: no one timed attempts.
- Phase 2: one timed shot attempts allowed.
- Rebound is played live.

**Key Teaching Points**

- G must have excellent ice awareness and anticipation skills.
- When the passout occurs on the nearside, G should have a depth focus and get off their post.
- When the passout occurs on the far side, G should have an angle focus to their positioning.
- When the passout occurs to the mid slot, G should get off post and not drift toward shooter.
- Regardless of passout type, a visual lead is vital.
- G should look to set up whenever possible to maximize control.

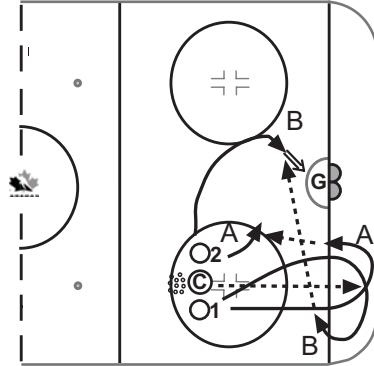



**Drill Name & Description**

**Developing a Battle Mindset**

- O1 will make a pass to coach, who will then make a return pass back.
- After making the return pass, coach will skate backwards, giving O1 a low lane to the net.
- O1 will take the puck to the net and try to beat G low to the farside of the net (i.e. net drive across the front and tuck the puck into the farside).
- All rebound are live and will continuously be put on net. All shots, including the initial one will all be along the ice and released in tight to the net – there is no raising of the puck but players may make as many dekes as they like.
- G will track all pucks properly and must refrain from using their stick on these plays.

**Key Teaching Points**

- To begin, G must have the mindset to battle.
- G must try to stay centered in the net without straying too far out or too far right or left.
- G should focus on complete low coverage first by having a deep crouch.
- Visual contact with the puck at all times is key regardless of body distortion.
- Goalie must have good backwards flow with shooter and not be stationary.

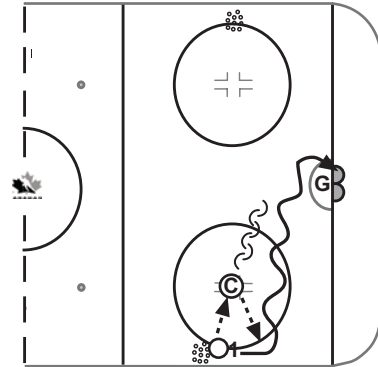



**Drill Name & Description**

**VH**

- This is a multi-phase drill to ensure that G's VH mechanics are sound.
- Phase 1: G will simply come to the post, from a mid goal line position and settle in to their VH position. Repeat 10 times to each side.
- Phase 2: O1 and pucks situated as indicated – on coach's "Go", O1 will step and jam the puck into G's positioning. Repeat 10 times to each side.
- Phase 3: O1 and pucks situated as indicated – on coach's "Go", O1 will step and shoot the puck into G's positioning. Repeat 10 times to each side.
- Phase 4: O1, coach and pucks situated as indicated – on coach's "Go", O1 will step and jam or shoot the puck into G's positioning OR if coach walks to the net from the far dot, O1 has the option of passing backdoor to coach. Repeat 5 times to each side.

**Key Teaching Points**

- This is a progressive drill to ensure mechanics are built soundly.
- Post leg remains vertical (V) while backside remains horizontal (H).
- Post skate should not over rotate – indeed, this skate must stay almost 90 degrees.
- Backside ankle stays near the goal line.
- Stick protects the seam between V and H on both sides.
- Glove side – glove remains high.
- Blocker side – glove supports stick for jam or can cover five hole if necessary.

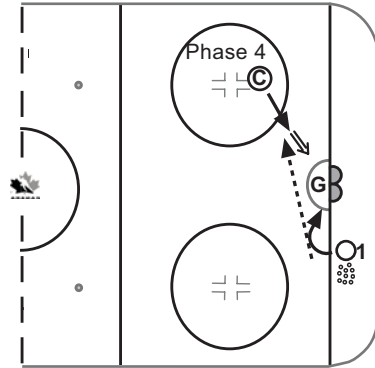



## Traffic Play

When it comes to traffic play a goaltender must battle hard to see the puck. It is absolutely essential to try to find the puck and keep your eye on it. It is probably the most effective way for any team to score, a good screen with a point shot can create rebounds and dangerous situations for any team.

There are many ways to teach a goaltender to look for the puck. The most efficient ways are to look around and overtop of the opposing player. I do not suggest looking low or trying to see through the legs of opposing players as this can get confusing and will result in too many legs and sticks to see through. Think of it in terms of trying to see through a forest. It is always easier to find your way out by looking over the forest rather than looking low through the trees.

When the puck is moving around the perimeter, whether it is on a powerplay or a game type situation, the goaltender may even opt to get more on their toes and look over the opposing player. This is an easy and effective way of seeing the puck at the point. I do suggest when the puck is at the point, the goaltender should be at a minimum depth of having their toes at the edge of the crease, and as the puck is moved lower, the goaltender can retreat to a lower depth. The goaltender should also try to remember to keep a piece of the blade of their stick on the ice at all times covering the five hole, as the majority of point shots will be low.

If there is a player in front I suggest your defenseman not get tied up with him as this can cause a double screen for your goaltender. Instead he should stay loose and take the opposing players stick and body when the shot has come. Your goaltender should also get as close to the opposing player doing the screening as possible without being overly aggressive, as this will eliminate the possibility of any tips or unlucky deflections.





**Drill Name & Description**

**Gap Control and Traffic Management**

- O1 passes to O2 at the point, O2 will drag the puck towards the center of the blue line before using some deception and stepping around either pylon.
- In no circumstance, should O2 shoot before there is a confrontation at the net between O1 and G.
- O2's shots should be wrist shots.
- Once the shot is taken and G either covers the puck up or tracks it, coach will hit O2 with a second puck (O2 will be standing at the blue line in the middle of the two pylons to receive the pass).
- O1, meanwhile, will arc away from the net and then, with good timing, come back towards the net for a tip or rebound on the second puck.

**Key Teaching Points**

- G should have quick-to-position movement in order to establish his position – making O1 form to G's position not vice versa.
- G maintains the strength of this position without getting excessively tangled up with O1.
- G can use the gloves to find a sight line or look above the traffic using partial flexion.
- G must keep battling for vision in this traffic instance.
- For the second puck, again, G must move into position with speed and must now anticipate the upcoming play.
- If it is likely deflection then G may have to slide towards the new trajectory and also be prepared to react if necessary.

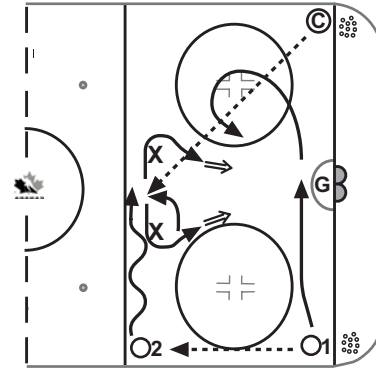



**Drill Name & Description**

**Proper Flexion**

- O1 will start with the puck, on the half boards, and make a pass to O2, who will proceed to make a pass to O3 – in each of these cases, the passing player will follow their pass and fill the spot vacated by the previous player.
- O3, after receiving the puck, will slide down to the half wall on the opposite side.
- O1, O2 and O3 will continue to move the puck around the perimeter (no cross-ice passes) until “shot” is called.
- One “shot” is called, the last player to receive the puck will release it on net.
- G will track the puck in a relaxed fashion and settle into a more set position once “shot” is called.
- To make it harder you can put players in front of goalie creating a screen.

**Key Teaching Points**

- G will establish partial flexion to preserve mobility – due to the obvious read, G’s desire is to maintain mobility given the likelihood of additional adjustments.
- G should use positional speed moving position to position.
- Major adjustments will use a T-push while minor adjustments will invoke a shuffle.
- By using partial flexion, G will be lighter on their feet, more aware, quicker to position.
- Once “shot” is called, G should be fully aware of ice.

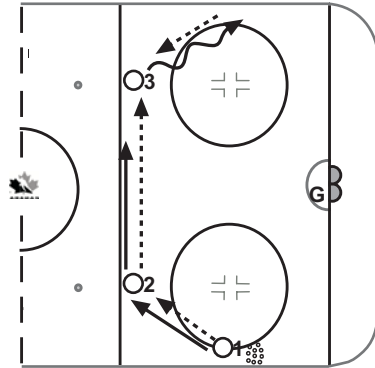

**Drill Name & Description**

**Traffic**

- O1 starts in front, and screens G.
- O2 passes cross ice to O3.
- O3 passes to O4 who shoots on G.
- G must find and follow puck.
- O2 crashes net after initial pass and goes for rebound.

**Key Teaching Points**

- Battle to look for puck while moving.
- Look over top and around player.
- Butterfly save will be best choice with a tight compact position.

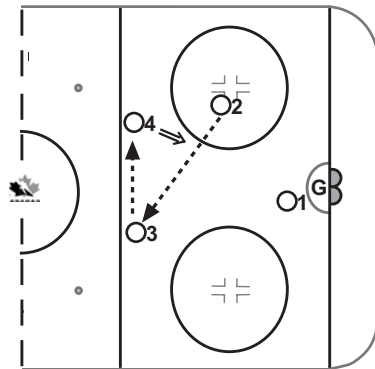





## Playing the Puck

A goaltender that can move the puck is a great advantage to any team. It will assist your defenseman and will help a team spend a lot less time in their own zone defensively if a goaltender can make smart effective plays with the puck. It is not about making breakaway passes up the middle or clearing the zone. It is about making quality outlet passes to their defenseman or forwards in order to help keep the opponent from forechecking the defensive zone.

The key to playing the puck for a goaltender is to:

- A. Read the forecheck as the puck is being dumped
- B. Get to the puck quickly
- C. Taking a look before making the play

When the goaltender is going out to play the puck in a soft dump situation, he must be aware of what is coming at him and where his best outlet may be. The forwards should get into a position where the goaltender can read that they are open to accept a pass and verbal communication is an absolute must. A nice option when the goaltender gets the puck behind the net is for both defensemen to peel off into the corners and be an outlet. This makes forechecking difficult as there are too many open players to cover.

In a hard rim situation, the goaltender has to be aware of anything that is dumped on the glass. I suggest not leaving the net on any hard rim around the glass, as strange bounces can occur from the partitions. Your goaltender may also have to hug the boards or even role with the dump behind the net if the rim is extremely hard. If the goaltender can slow the puck down it may make it easier for a defenseman to get to.

In the end a goaltender that can play the puck greatly reduces the number of scoring chances against and can kill any forecheck in an instance. It may also help save a team's defense from injury and the wear and tear of being hit.





**Drill Name & Description**  
**Playing the Puck (time)**

- Coaches with pucks at redline hard rim puck.
- G stops hard rim, turns and gives outlet pass to O1.
- Repeat hard rim.
- G gives outlet pass to O2.
- Repeat rim.
- G gives stretch pass to O3.
- Do 3-5 reps for each pass.
- Do both sides.

**Key Teaching Points**

- Stopping hard rim, turning and looking up ice.
- Hard tape to tape passes.
- Checking shoulders before going behind net.

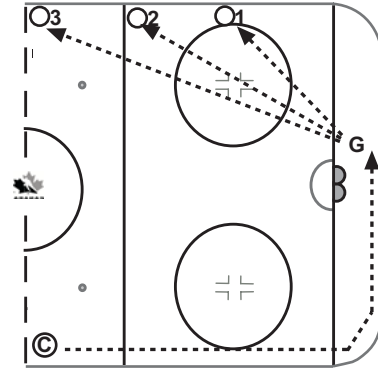

**Drill Name & Description**  
**Playing the Puck (with pressure)**

- Hard rim or soft dump on G.
- O1 forechecks.
- O2 and O3 move to wall for outlet pass.

**Key Teaching Points**

- G must look.
- Hard pass tape to tape.
- Shoulder check.

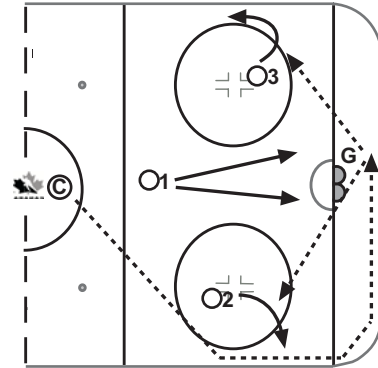

**Drill Name & Description**  
**Playing the Puck (no time)**

- Hard rim.
- G stops puck.
- Clears every time high on glass.
- O1 pressures G to put rim high.
- Can do from both sides.
- 5-10 reps.

**Key Teaching Points**

- When giving up puck, make sure high on glass.
- Turning and taking a look up ice.
- Taking a look before going to get puck.

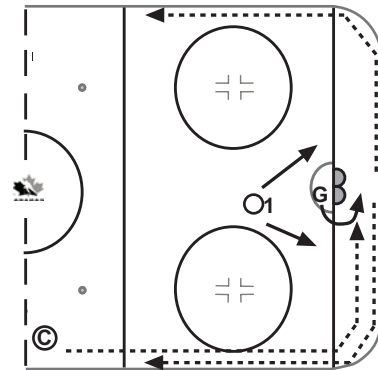



**PLAYER DEVELOPMENT**  
Développement des joueurs

\*Goaltender playing the puck can be substituted for any breakout drill. Hard rim to goaltender or soft dump and allow goaltender to start breakout by making an outlet pass or leaving the puck for defenseman.



**PLAYER DEVELOPMENT**  
Développement des joueurs



## **Breakaways and Shootouts**

With shootouts being used as a deciding factor in a lot of international competition, it is becoming increasingly important to have your goaltender be a solid one-on-one player. The whole mindset of your goaltender should be to try to force the opposing player to deke or go around him. This can result in a player finding themselves in a number of bad situations such as losing the puck or simply running out of room in an attempt to score. The on ice conditions should be looked at as an x-factor for your goaltender in the sense that the game has been played and normally the ice will be in less than perfect condition. So if you can force a player to deke, he runs the risk of trying to make a play on bad ice. The goaltender should be as patient as possible and allow the player to always make the first move.

In a breakaway or shootout situation your goaltender should try to “start high and finish low”. This meaning they should be aggressive on the shooter initially by trying to get out of their crease on the whistle and follow the player by backing in with them. The goaltender should think of it in defensive terms such as closing the gap and matching the opposing players speed. It is then important for the goaltender to make their movements in a Y formation. To explain this properly it means for the goaltender to get out to a starting position, to back in on a straight line and then to make a butterfly save or movement toward whichever post the opposing player tries to make their move to. When the goaltender drops into their butterfly, they should be compact and not leave any holes through the body. They should remember always to bring the stick with them to cover the five-hole.

The last important piece is for a goaltender to avoid dropping their glove to early opening an easy shot for an opposing player to pick. If this is done correctly the goaltender should see success often and will have an advantage over the shooter.





**Drill Name & Description**

**Breakaways**

- Pucks at blueline.
- O1 comes in on breakaway.
- G must start on goal line and get up and out on shooter.
- O2 then goes on angle breakaway.
- O3 then goes on angle breakaway.

**Key Teaching Points**

- Proper spacing between shots.
- Get up and out on shooter.
- Force them to deke.
- Patience.

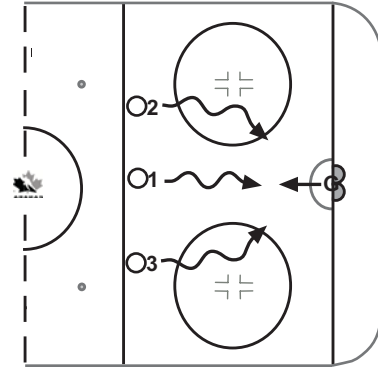

**Drill Name & Description**

**Behind Net (Patience, Stay on Feet)**

- O1 off to side behind net with pucks.
- O2 in front of net gets pass from behind net into low slot.
- O2 has short breakaway on G in tight.
- G must stay on feet and get to top of crease as fast as he can.
- G start on post.
- No one timers.

**Key Teaching Points**

- Patience, out wait shooter.
- Strong push to get off post.

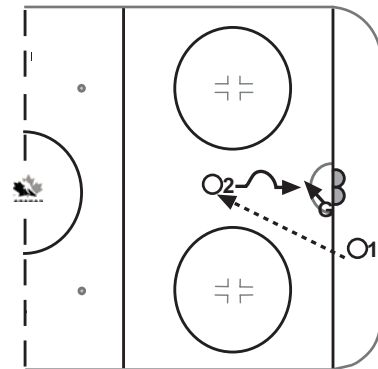

**Drill Name & Description**

**Breakaways with Trailer**

- Breakaway for O1.
- O2 does everything to distract O1 by making it difficult to let him shoot.
- G must start on goal line, get up on shooter.

**Key Teaching Points**

- G must stay patient knowing shooter will not get a clear shot off.
- Speed for G while player is distracted.
- O2 must let O1 get shot off, but must have made it difficult for him.

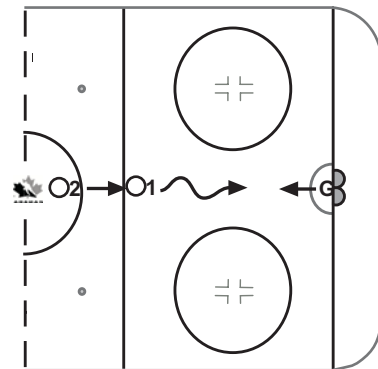



**Drill Name & Description**

**Tight Angle Breakaway**

- Pass from coach down low to player who cuts to net for side angle breakaway.
- Ability to move cones higher and do same drill giving more or less room.
- G starts by fronting coach.

**Key Teaching Points**

- G must adjust depth by backing off slowly.
- G must get good momentum with strong hip rotation.
- G will need to have patience and stay on their feet.
- G will need to make quick lateral adjustment.
- G cannot use VH.

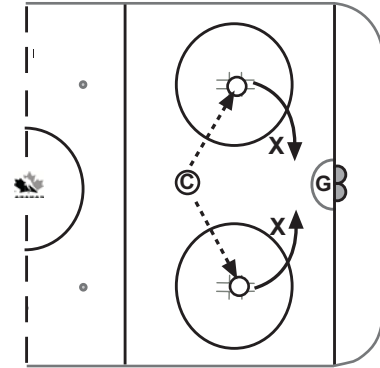

**Drill Name & Description**

**Shootout**

- Pucks at center.
- Players divided into two teams.
- Coach blows whistle and player from each team goes on breakaway against opposite goalies.
- After initial breakaway player skates back to center ice and takes breakaway on opposite goalie.

**Key Teaching Points**

- Breakaway with shootout mentality.
- Goalie gets two breakaways instead of one.

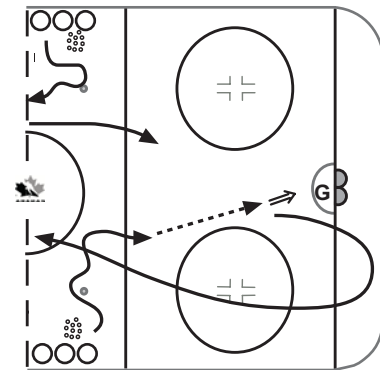





**PLAYER DEVELOPMENT**  
Développement des joueurs

## **APPENDIX**

### **Practice Plans**